

Electron-Beam Deflection Tube D 1000651

Instruction sheet

10/15 ALF

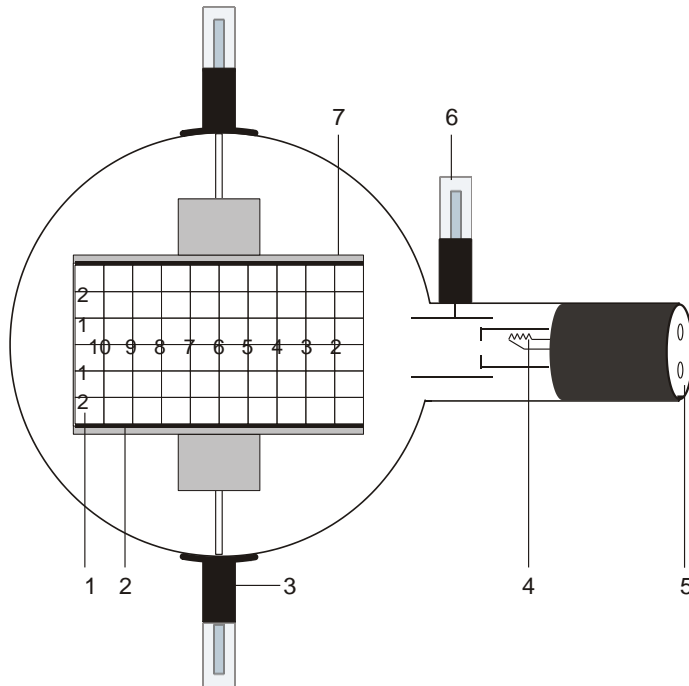

- 1 Fluorescent screen
- 2 Lower deflection plate
- 3 Boss with 4-mm plug for connecting deflection plates
- 4 Electron gun
- 5 4-mm sockets for connecting heater supply and cathode
- 6 4-mm plug for connecting anode
- 7 Upper deflection plate

1. Safety instructions

Hot cathode tubes are thin-walled, highly evacuated glass tubes. Treat them carefully as there is a risk of implosion.

- Do not subject the tube to mechanical stresses.
- Do not subject the connection leads to any tension.
- The tube may only be used with tube holder D (1008507).

If voltage or current is too high or the cathode is at the wrong temperature, it can lead to the tube becoming destroyed.

- Do not exceed the stated operating parameters.
- Only change circuit with power supply equipment switched off.
- Only exchange tubes with power supply equipment switched off.

When the tube is in operation, the stock of the tube may get hot.

- If necessary, allow the tube to cool before dismantling.

The compliance with the EC directive on electromagnetic compatibility is only guaranteed when using the recommended power supplies.

2. Description

The electron-beam deflection tube is intended for investigating the deflection of electron beams in electrical and magnetic fields. It can be used to estimate the specific charge of an electron e/m and to determine the electron velocity v .

The electron-beam deflection tube comprises an electron gun which emits a narrow, focussed ribbon of cathode rays within an evacuated, clear glass bulb. A tungsten 'hairpin' filament hot cathode is heated directly and the anode takes the form of a cylinder. The deflection of rays can be achieved electrostatically by means of a built-in plate capacitor formed by the pair of deflection plates or magnetically with the help of the Helmholtz coils D (1000644) magnetically. The cathode rays are intercepted by a flat mica sheet, one side of which is coated with a fluorescent screen and the other side of which is printed with a centimetre graticule so that the path of the electrons can be easily traced. The mica sheet is held at 15° to the axis of the tube by the two deflecting plates.

3. Technical data

Filament voltage:	≤ 7,5 V AC/DC
Anode voltage:	1000 V – 5000 V DC
Anode current:	0.1 mA approx. at 4000 V
Deflector plate voltage:	5000 V max.
Distance between plates:	54 mm approx.
Fluorescent screen:	90 mm x 60 mm
Glass bulb:	130 mm Ø approx.
Total length:	260 mm approx.

4. Operation

To perform experiments using the electron-beam deflection tube, the following equipment is also required:

1 Tube holder D	1008507
2 High voltage power supply 5 kV (115 V, 50/60 Hz)	1003309
or	
2 High voltage power supply 5 kV (230 V, 50/60 Hz)	1003310
1 Helmholtz pair of coils D	1000644
1 DC power supply 20 V (115 V, 50/60 Hz)	1003311
or	
1 DC power supply 20 V (230 V, 50/60 Hz)	1003312
1 Analogue multimeter AM51	1003074

Additionally recommended:
Protective Adapter, 2-Pole 1009961

4.1 Setting up the tube in the tube holder

- The tube should not be mounted or removed unless all power supplies are disconnected.
- Push the jaw clamp sliders on the stanchion of the tube holder right back so that the jaws open.
- Push the bosses of the tube into the jaws.
- Push the jaw clamps forward on the stanchions to secure the tube within the jaws.
- If necessary plug the protective adapter onto the connector sockets for the tube.

4.2 Removing the tube from the tube holder

- To remove the tube, push the jaw clamps right back again and take the tube out of the jaws.

5. Example experiments

5.1 Magnetic deflection

- Set up the tube as in Fig. 2. Connect the minus-pole of the anode voltage to the 4-mm socket marked with a minus.

- Insert the Helmholtz tubes into the holes of the tube holder.
- Turn on the high-tension power supply.
- Energise the Helmholtz coils and observe the path of the beam.

The path of the luminous beam is circular, the deflection being in a plane perpendicular to the electromagnetic field.

At fixed anode voltage the radius decreases with increasing coil current.

With a fixed coil current the radius increases with increasing anode potential, indicating a higher velocity.

An electron of mass m and charge e moving perpendicular to a uniform magnetic field B at velocity v is deflected by the Lorentz force Bev onto a circular path of radius r .

$$B \cdot e \cdot v = \frac{m \cdot v^2}{r} \quad (1)$$

5.2 Electric deflection

- Set up the tube as in fig 3. Connect the minus-pole of the anode voltage to the 4-mm socket marked with a minus.
- Turn on the high-tension power supply.
- Switch on the deflector plate voltage and observe the path of the beam.

An electron with velocity v passing through the electric field E produced by a plate capacitor held at a voltage U_P with a plate spacing d is deflected into the curved path of a parabola governed by the equation:

$$y = \frac{1}{2} \cdot \frac{e}{m} \cdot \frac{E}{v^2} \cdot x^2 \quad (2)$$

where y is the linear deflection achieved over a linear distance x .

5.3 Calculating e/m und v

5.3.1 By means of magnetic deflection

- Set up the experiment as in Fig 2.

The velocity is dependent on the anode voltage U_A such that:

$$v = \sqrt{2 \cdot \frac{e}{m} \cdot U_A} \quad (3)$$

Solving equations 1 and 3 simultaneous gives the following expression for the specific charge e/m :

$$\frac{e}{m} = \frac{2 \cdot U_A}{(B \cdot r)^2} \quad (4)$$

U_A can be measured directly, B and r can be determined experimentally.

5.3.1.1 Determining r

The radius of curvature r is obtained geometrically as in Fig. 1:

$$r^2 = x^2 + (r-y)^2$$

so that:

$$r = \frac{x^2 + y^2}{2 \cdot y} \quad (5)$$

5.3.1.2 Calculating B

The magnetic flux B of a magnetic field generated by the Helmholtz coils in Helmholtz geometry and the coil current I can be calculated:

$$B = \left(\frac{4}{5}\right)^{\frac{3}{2}} \cdot \frac{\mu_0 \cdot n}{R} \cdot I = k \cdot I \quad (6)$$

where $k =$ in good approximation 4,2 mT/A with $n = 320$ (windings) and $R = 68$ mm (coil radius).

5.3.2 By means of electric deflection

- Set up the experiment as in Fig 3.

e/m can be calculated from equation 2:

$$\frac{e}{m} = \frac{2y}{E} \frac{v^2}{x^2} \quad (7)$$

where $E = \frac{U_P}{d}$

with $U_P =$ deflector plate voltage and $d =$ plate spacing.

5.3.3 By means of field compensation

- Set up the experiment as in Fig 4.
- Turn on the high-tension power supply units and deflect the beam electrically.
- Energise the Helmholtz coils and adjust the voltage in such a way that the magnetic field compensates the electric field and the beam is no longer deflected.

The magnetic field compensates the deflection of the electron beam caused by the electric field:

$$e \cdot E = e \cdot v \cdot B$$

The velocity v can be calculated:

$$v = \frac{E}{B} \quad (8)$$

where $E = \frac{U_P}{d}$. For the calculation of B refer to point 5.3.1.2.

The specific charge e/m can be calculated:

$$\frac{e}{m} = \frac{1}{2 \cdot U_A} \cdot \left(\frac{E}{B}\right)^2 \quad (9)$$

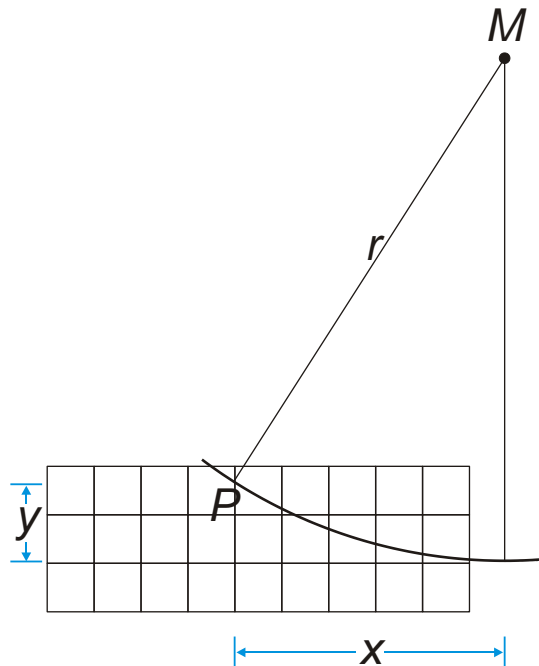

Fig. 1 Determining r

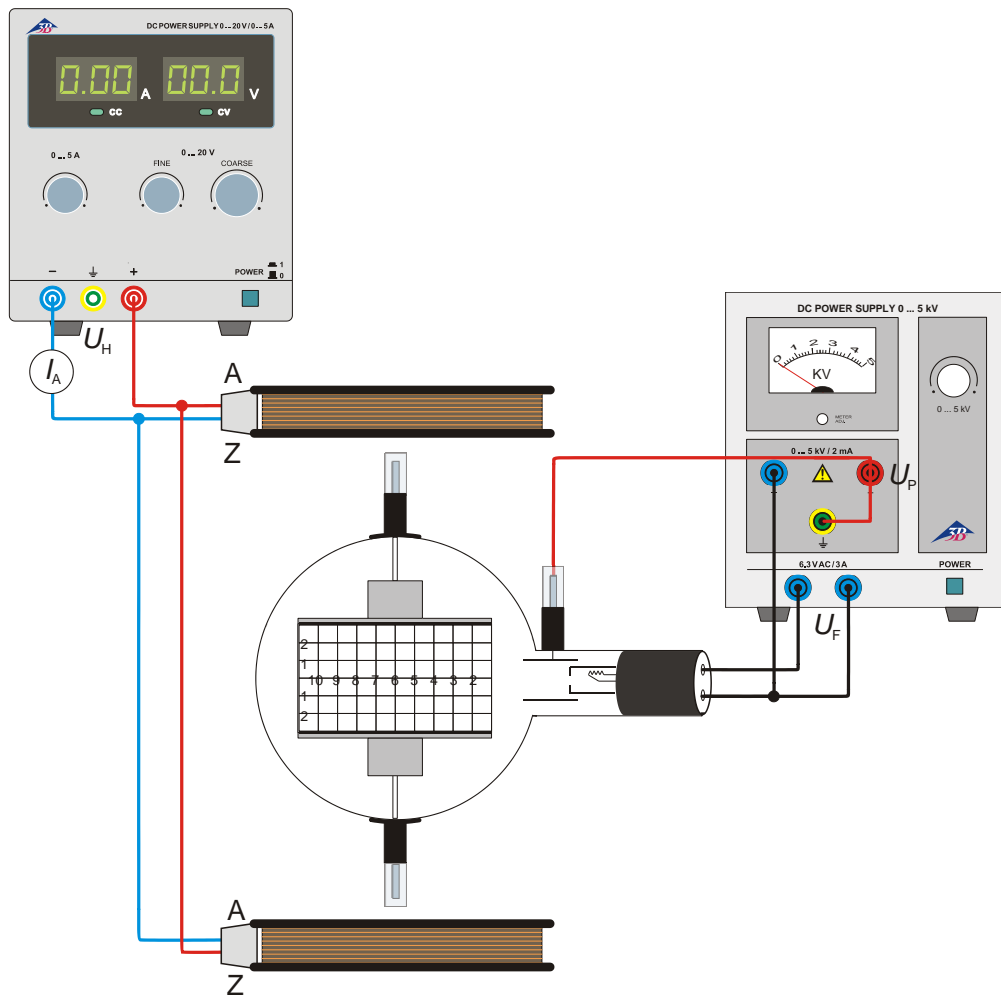

Fig. 2 Magnetic deflection

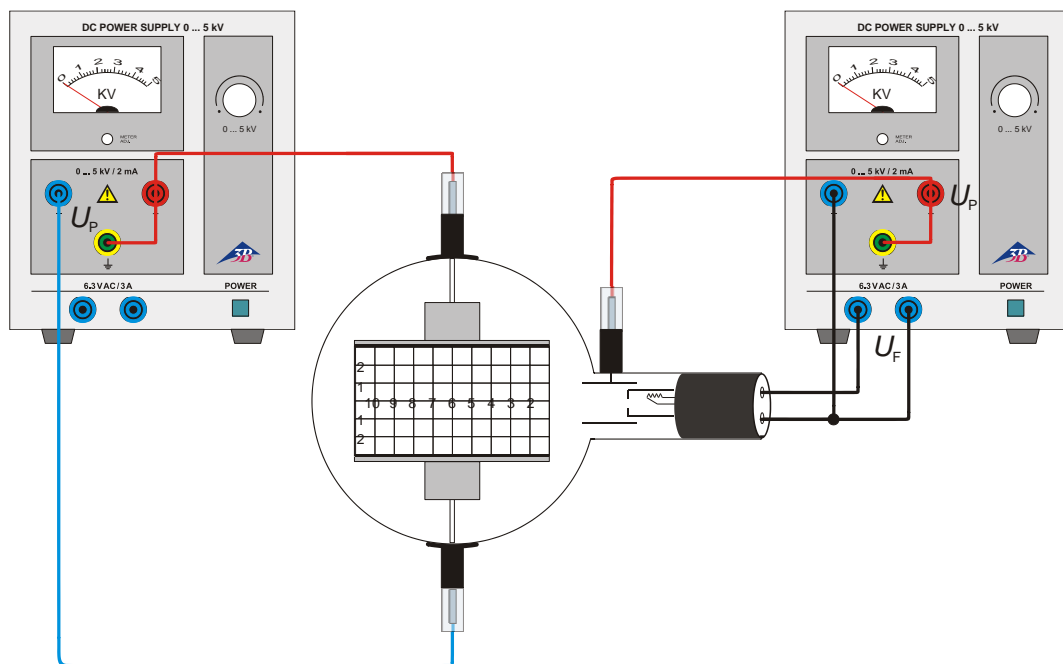

Fig.3 Electric deflection

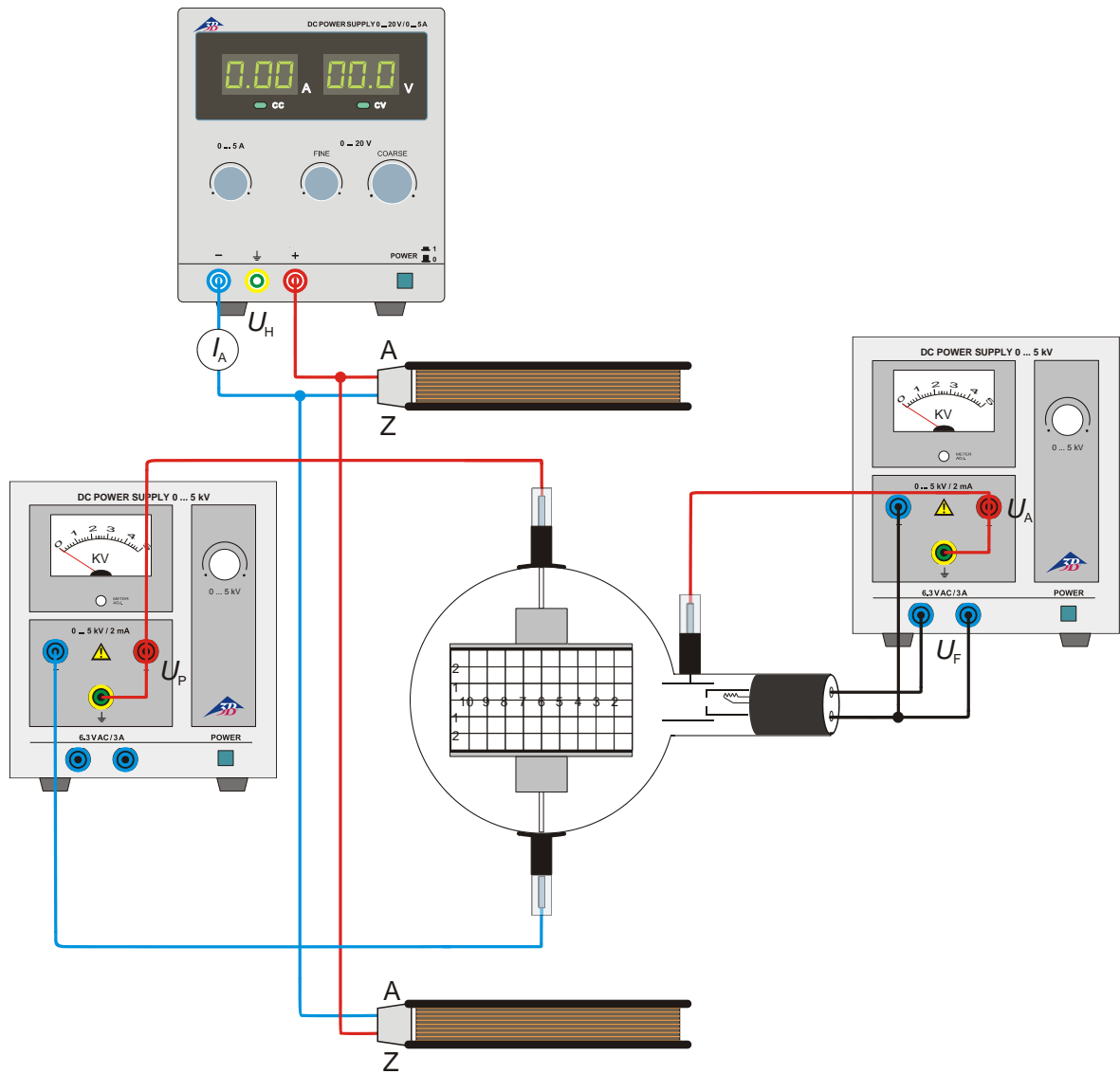

Fig. 4 Calculating e/m by means of field compensation

