

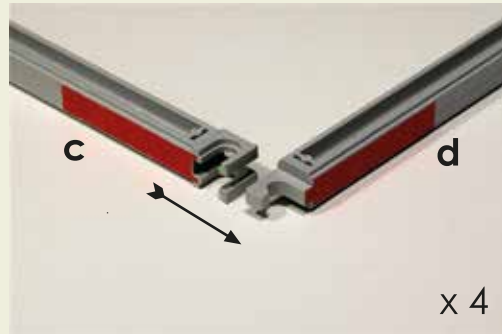

6 x a		1 x c	
3 x b		1 x d	
		1 x e	

1.1

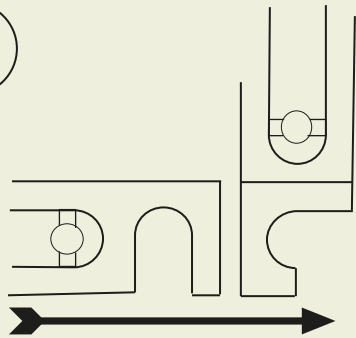

1.2

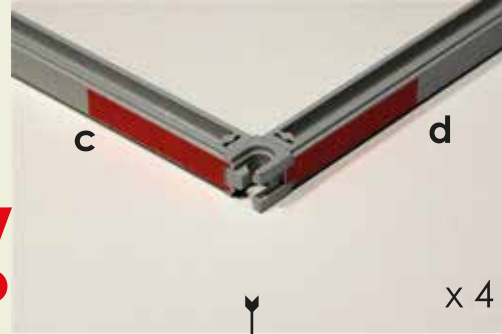
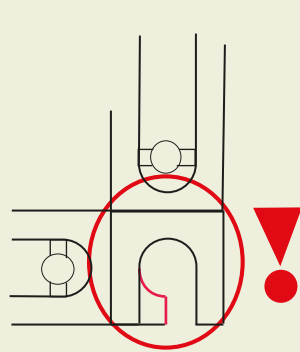

2.1

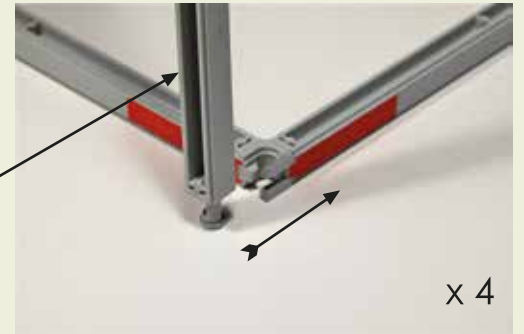

2.2

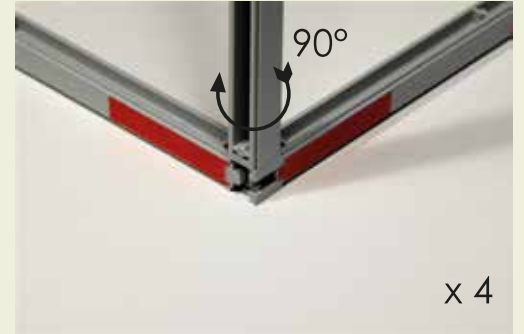

2.3

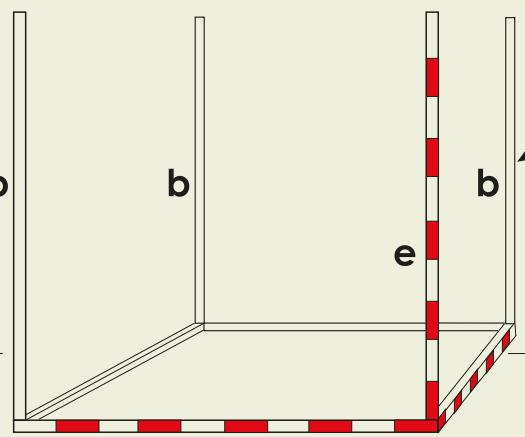
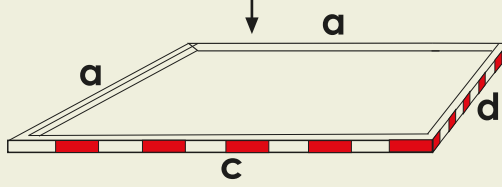
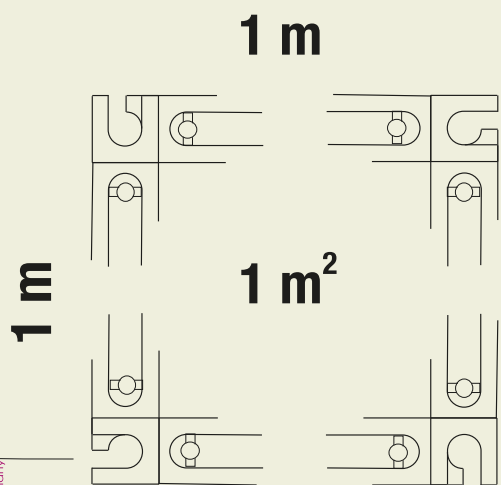



3.1

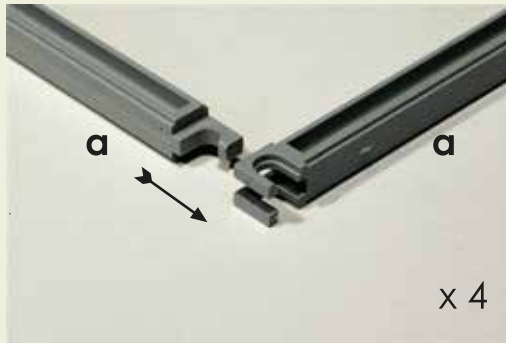
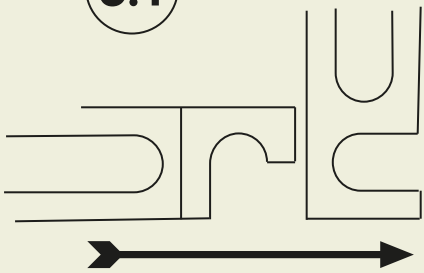

3.2

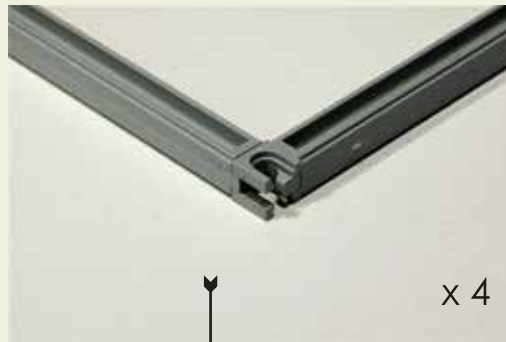
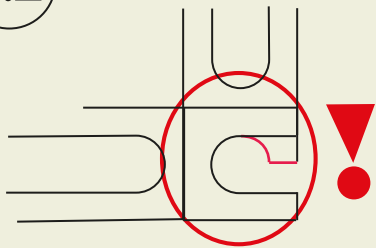

4.1

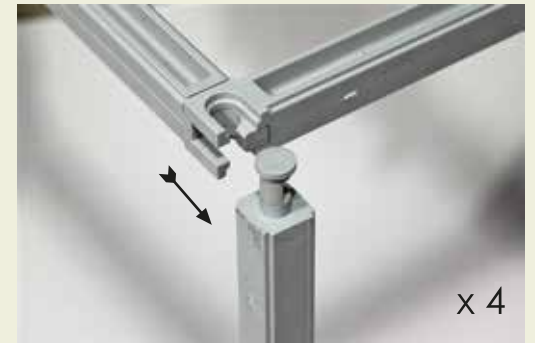

4.2



3.3

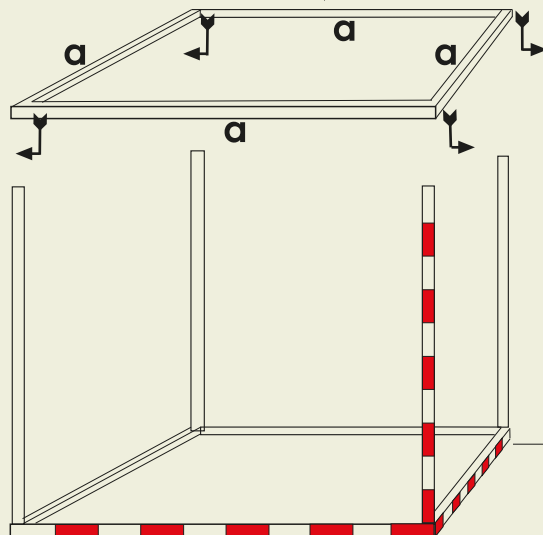
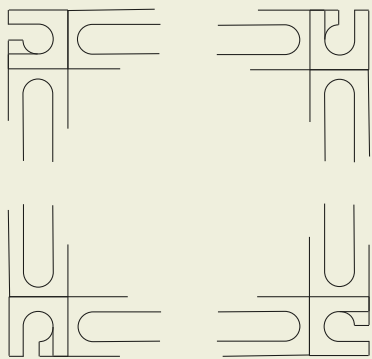

4.3

