

PHYWE Systems GmbH & Co. KG  
Robert Bosch width 10  
D-37079 Goettingen, Germany

Phone +49 (0) 551 604-0  
fax +49 (0) 551 604-107  
E-mailinfo@phywe.de

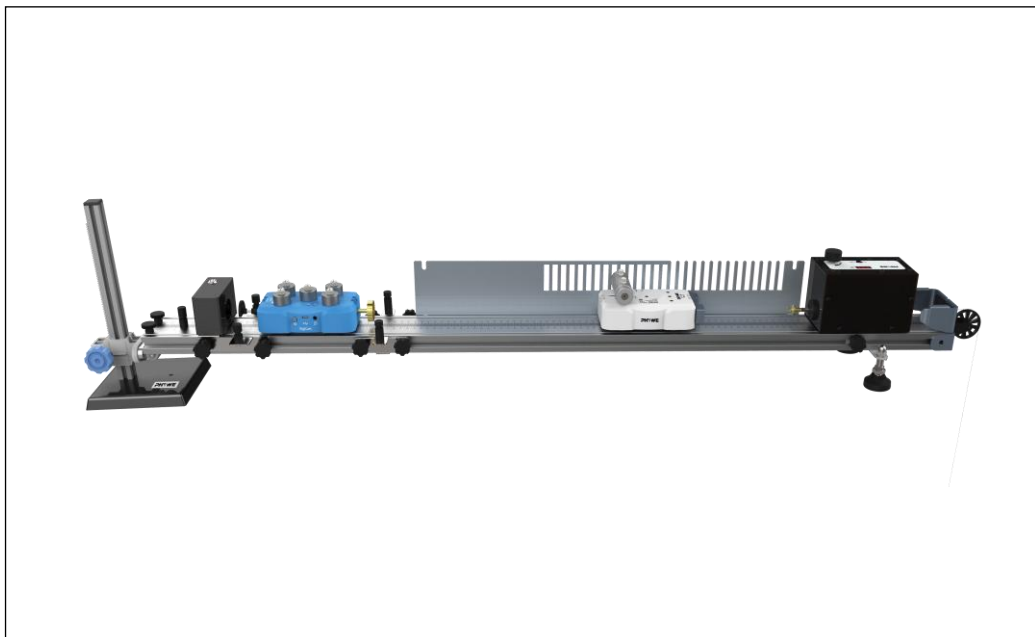

## instruction manual

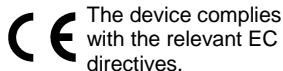

Fig. 1: 12940-88 Cobra DigiCart Expert Set

## TABLE OF CONTENTS

### 1 SAFETYINFORMATION

### 2 PURPOSE AND CHARACTERISTICS

### 3 FUNCTIONAL AND OPERATING ELEMENTS

### 4 HANDLING

### 5 OPERATING INSTRUCTIONS

### 6 TECHNICAL DATA (DIGICART)

### 7 CONFORMITY

### 8 DISPOSAL

- Protect the device from dust, moisture and vapours. Only clean the device when it is disconnected from the mains voltage with a slightly damp, lint-free cloth. Sharp cleaning agents or solvents are unsuitable.
- Always use only the power supply supplied with the vibration motor.
- The cart can be charged via the USB-C port on the side. Please charge the car in good time and do not keep the battery low for long periods of time.
- If the temperature of the device rises or any other suspicious phenomenon is detected, the power must be immediately cut off.
- When the vehicle is fully charged, the charger should be removed so as not to affect battery life.
- If the car is not used for a longer period of time, it is advisable to load it approx. every 3 months.
- Avoid scratching the sheet with sharp objects, especially the surface of the scale line.
- For selective experiments, avoid direct impacts on the car or excessive acceleration.

### 1 SAFETYINFORMATION



#### Attention!

- Before operation of the device, read the operating instructions carefully and completely. You protect yourself and avoid damage to your device.
- Do not operate the device if damage is visible.
- Use the device only for its intended purpose.
- Do not open the device.

## 2 PURPOSE AND CHARACTERISTICS

The Cobra DigiCart Sets can be used to perform a variety of experiments on dynamics. The DigiCarts have several built-in sensors. Many related physical quantities such as motion, velocity, acceleration, force, kinetic energy and momentum can be studied. The measured values are transmitted via wireless data transmission in the Bluetooth 4 standard. Low-friction rollers ensure unadulterated measurements.

## 3 FUNCTIONAL AND OPERATING ELEMENTS

### 3.1 Experiments

Experiments on the following topics of dynamics can be carried out:

- kinematics
- Newtonian laws
- Inclined plane
- Pulse / Pulse conservation sentence
- law of conservation of energy
- Electromagnetic Damping
- Vibrations and resonance

### 3.2 PHYWE DigiCart

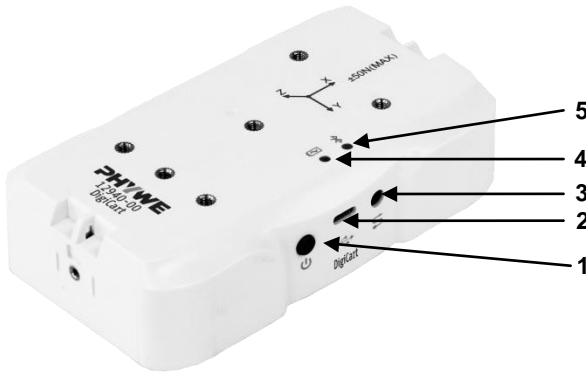

1. Power switch (press 3s to switch on)
2. USB-C port (for charging)
3. 5 V voltage output (for connecting optional accessories)
4. battery indicator
5. Bluetooth indicator



The Cobra DigiCart Basic Set 12940-77 includes a white trolley.



The Expert Set 12940-88 contains 2 trolleys, one white and one blue. These can be used in the experiment "P6201000 conservation of momentum".

The DigiCarts have a rechargeable lithium-ion battery (3.7V / 1800mAh). The battery may only be replaced by authorised specialist personnel.

### carriageway



Height-adjustable 1.2 m long carriageway with scale (mm).

### Height adjustable brackets



The necessary screws and nuts for the holders are in the accessory boxes.

### 3.3 Electromagnetic components

#### Electromagnetic starting device

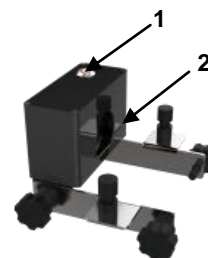

1. Push-button switch for triggering
2. 12 V Voltage input

The electromagnetic starting device is operated with the power supply unit of the vibration motor. (see 3.5 Power supplies).

When the push button is pressed, the carriage starts moving.

## Mechanical starting device



## Adjustable vibration generator with digital display



The vibration generator is used to investigate forced vibrations and resonances and is only included in the Expert Set. It is operated with a plug-in power supply (see 3.5 Power Supplies) and has a 12 Volt voltage input.



### Attention!

- Don't touch it.
- Only put into operation when the vibration generator is mounted on the road.

## 3.4 Magnetic damping components

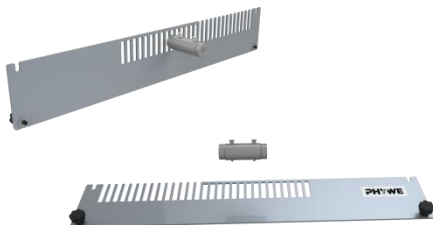

The necessary screws, nuts and gaskets are included in the accessory boxes.

The damping components are only included in the Expert Set.

## car receiver



## Accessories

### Accessory set A

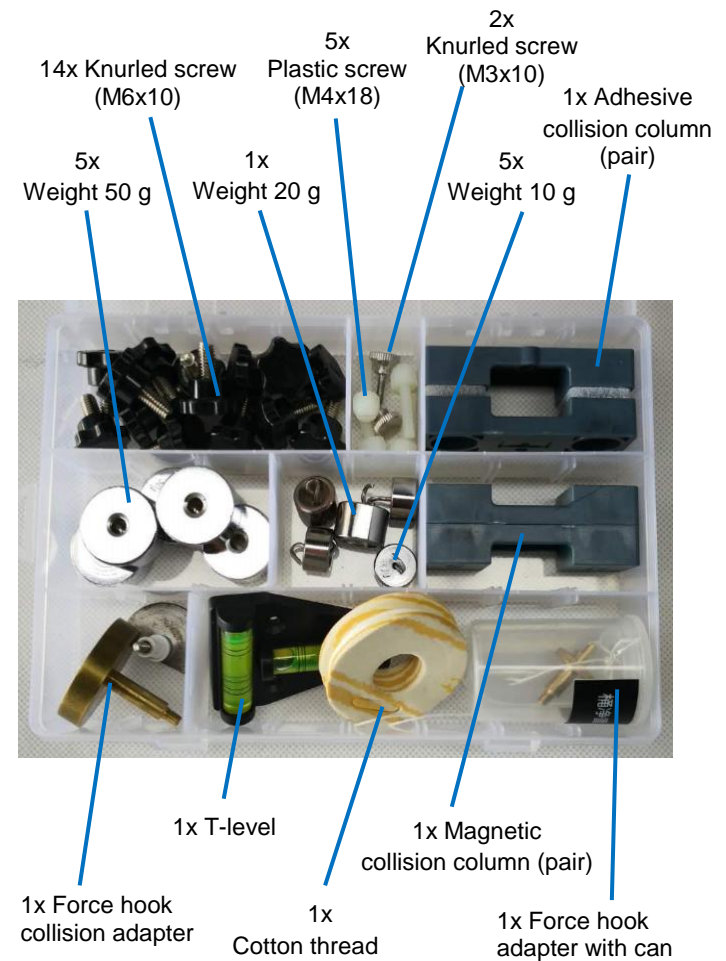

### Accessory set B

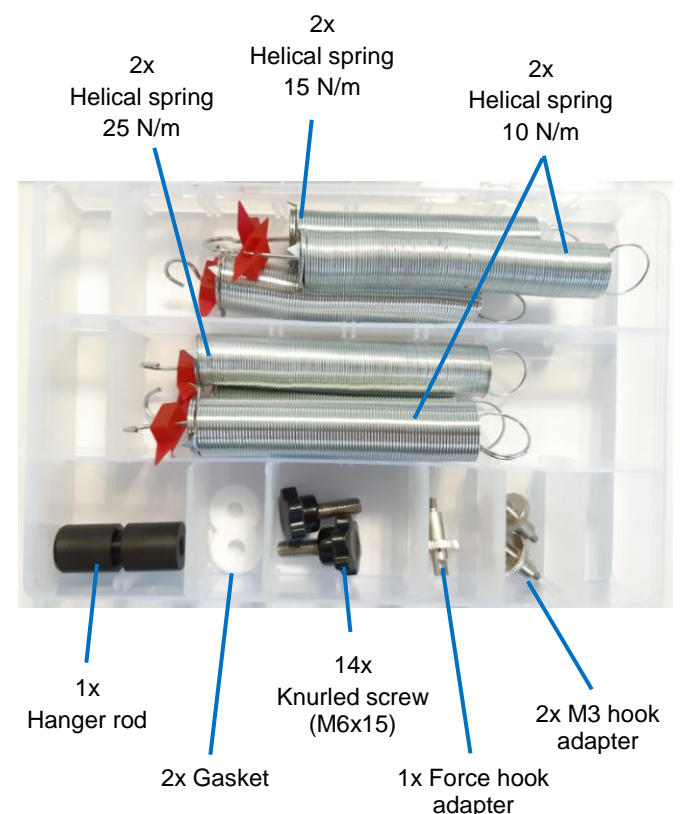

## rubber bands



To be attached to the starting device.

## Electronic balance



Measuring range: 1000g

Accuracy: 0.1 g

## 3.5 Power supply units

### 3.5.1 Safety Instructions



#### Attention!

- The operating instructions must be read carefully and completely before putting the device into operation. You protect yourself and avoid damage to your device.
- Make sure that the mains voltage specified on the type plate of the device corresponds to that of your mains supply.
- The unit must be set up in such a way that the mains switch or plug are freely accessible. The ventilation slots of the device must not be covered.
- Make sure that no liquids or objects get into the ventilation slots of the device.
- The device is only intended for use in dry rooms where there is no risk of explosion.
- Use the device only for its intended purpose.
- Protect the device from dust, moisture and vapours. Only clean the device when it is free of mains voltage with a slightly damp, lint-free cloth. Sharp cleaning agents or solvents are unsuitable.
- Do not operate the device if damage to the device, power cord or test leads is visible.
- Do not open the device.

### 3.5.2 Purpose and characteristics

Sets 12940-88 and 12940-77 include the following power supplies:

1. Power supply with USB socket for charging the DigiCarts.
2. Plug-in power supply with DC socket for the starting device and the vibration generator (only in 12940-88).

## 3.5.3 Technical Data

One:



Input voltage range:	100...240 V~
Mains frequency:	50...60 Hz
Output voltage:	5 V
Output current:	1 A

Two:



Input voltage range:	100...240 V~
Mains frequency:	50...60 Hz
Output voltage:	12 V
Output current:	2 A
DC socket:	2,1 mm

## 4 HANDLING

### 4.1 Installing the carriageway

Place one end of the carriageway on the small bracket. Since the car receiver still has to be mounted later, it is better to place the carriageway approx. 10 cm away from the end. Slide the bolt into the side groove of the carriageway and tighten the nut (see Figure 2). Fasten the holder and rail together (see Figure 3).



Fig.2 Screw and nut for fixing the carriageway



Fig. 3 Permanently mounted small holder

Mount the cart holder to the top of the small holder and secure it with the bolt and nut (see Figure 4).



Fig. 4 Car receiver

Fasten the other end of the track to the lifting frame using a hand screw and holes. Loosen the fixed knob (small silver knob) on the lifting frame and turn the blue screw to hold the track horizontally. Then tighten the hand screw (see figure 5).



Fig. 5 Mounted lifting frame

Note: The holes at the top of the rail are for mounting black columns, which are used as the fixed end of the spring in the vibration and resonance experiments.

## 2.2 Using an Electromagnetic Launcher

a) Attach the fan-shaped iron to the rear of the carriage using the connecting rod (see Figure 6).



Fig. 6 The wagon mounted with iron stern

b) When the electromagnet is switched on, the car clings to the trigger until it is switched off.

c) If a rubber band is attached to the trigger (two black columns), the trolleys can be started in a controlled manner via the electromagnet. If the electromagnet is switched on, the trolley is kept in a static state and waits for the start (Fig. 7).



Fig. 7: The car is waiting for the start at the release button.

### clues

- When experimenting, make sure that the cars do not fall to the ground.
- The speed of the car should not be too high during the experiments on the impulse/impulse conservation theorem.

## 5 OPERATING INSTRUCTIONS

This quality device meets the technical requirements summarized in the current European Community directives. The product properties entitle the user to CE-marking.

This device may only be operated under expert supervision in a controlled electromagnetic environment of research, teaching and training facilities (schools, universities, institutes and laboratories).

The individual connected lines must not be longer than 2 m .

Electromagnetic phenomena (HF, burst, indirect lightning discharges, etc.) can influence the device so that it no longer operates within the specified data. The following measures reduce or eliminate the disturbing influence: Avoid carpeting; ensure equipotential bonding; experiment on a conductive, grounded base, use of shielding, shielded cables.

## 6 TECHNICAL DATA (DIGICART)

### Force sensor:

Measuring range:  $\pm 10\text{N}$ ,  
Resolution: 0,03N  
Max sampling rate: 5000 Hz

Measuring range:  $\pm 50\text{N}$   
Resolution: 0.03N,  
Max sampling rate: 5000 Hz

### Speed and position sensor:

Speed: 3m/s  
Resolution: 0.001 m/s  
Position resolution: 0.1 mm  
Max. Sampling rate: 800/s

### Accelerometer:

Measuring range: 16 g  
Resolution: 0.01 g  
Max. Sampling rate: 500 Hz

Communication range 0...30m (outdoors)

## 7 CONFORMITY



PHYWE Systeme GmbH & Co.KG hereby declares that the radio system type 12940-88 / 12940-77 complies with the 2014/53/EU directive. The complete text of the EC Declaration of Conformity is available at the following Internet address:  
[www.phywe.com/en/ec-declaration](http://www.phywe.com/en/ec-declaration)

## 8 DISPOSAL

The packaging consists mainly of environmentally friendly materials, which should be sent to the local recycling points.



This product does not belong in the normal garbage disposal (household garbage). If this device is to be disposed of, please send it to the address below for professional disposal.

PHYWE Systeme GmbH & Co. KG Department  
Customer Service Robert-Bosch-Breite  
10D-37079 Göttingen

Phone+ 49 (0) 551 604-274 Fax+  
49 ( 0) 551 604-246