



CPR*Lilly* PRO+

USER INSTRUCTIONS

> CONTENTS

Resuscitation simulator CPRLilly PRO+	03
Functions	04
Scope of delivery	05
Quick guide for changing the ventilation unit	06
Switching on and off.....	07
Assembly and use	
Battery replacement.....	08
Training	09
Introduction	
1. Downloading and starting the software application	
2. Creating a user account ("Student Profile")	10
3. General controls and icons 11	
4. Logging in as a trainee with a user account ("Student Simulator Access")	12
4.1. Training	
4.2. Test.....	15
4.3. CPR Guide	
4.4 Settings.....	16
5. Logging in as a trainer ("Instructor Access")	17
5.1 Training.....	18
5.2. Test.....	20
5.3. Monitor.....	22
5.4. Results.....	23
5.5. CPR Guide.....	24
5.6. Settings.....	25
5.6.1. About us	
5.6.2. Parameters	
5.6.3. Languages and units.....	26
5.6.4. Network	
5.6.5. Administration.....	27
5.6.6. Select simulators.....	28
6. Network operation	29
6.1 Router-based network operations	
6.1.1. Network operation when using a desktop computer.....	30
6.2 Restricted network operation.....	32
7. Use of an AED device	34
General safety instructions	35
FAQ	
Cleaning and maintenance	36
Technical data	
Connected load	
Order list	
Company information	

CPRLilly PRO+

Thank you for purchasing a 3B Scientific® product. Please read the operating instructions carefully before starting the device up so that trouble-free operation is guaranteed and you can work satisfactorily with this product.

The CPRLilly PRO+ is a practice model for cardiopulmonary resuscitation (CPR). The simulator meets the latest CPR guidelines from the AHA (American Heart Association) and ERC (European Resuscitation Council), version of 2019. Its robust construction, ease of use and realistic application make it suitable for both medical education and basic first aid training in schools, clubs and for first aid courses. It offers all the required features for practicing the vital algorithm of adult heart massage and artificial respiration.



Note:

The didactic focus of the CPRLilly PRO+ is on a realistic feel of the compressions and the interactive feedback system. A realistic design of the anatomical structures was implemented insofar as possible. Individual structures can be shown schematically.



CPRLilly PRO+

> FUNCTIONS

- Torso with shoulders and necessary anatomical features to find the ideal pressure point for cardiac massage
- Head with airways for mouth-to-mouth and mouth-to-nose ventilation
- Head tilt-chin lift maneuver to clear the airways
- Use of the jaw-thrust maneuver to clear the airways when the head tilt-chin lift maneuver is contraindicated
- Mask ventilation is possible
- Intuitive, software-supported feedback system with up to 10 CPRLilly PRO+ units networked for efficient and cost-effective group training
- Realistic recoil of the thorax and a compression depth of 5 - 6 cm required according to the guidelines
- Affordable disposable throat bags ensure hygienic application as well as convenient cleaning and care of the simulator
- The CPRLilly PRO+ has two decoupled air circuits. The advantage: The respiratory air of the user goes exclusively into the disposable throat bag. The inner circuit is not affected by proper use and therefore does not have to be replaced.
- The CPRLilly PRO+ has been developed and manufactured in Germany

In the development of the CPRLilly PRO+, we put special emphasis on quick and easy operation, especially with regard to hygiene and to courses with larger groups. The face mask is dishwasher safe and can be bought later. You can, therefore, provide each student with his or her own mask and own disposable throat bag for maximum hygiene.



Also suitable for courses involving larger groups

CPRLilly PRO+

> SCOPE OF DELIVERY

- 1 CPRLilly PRO+ Simulator
 - 4 lower face masks (including teeth)
 - 25 throat bags
 - 1 carrying case (can be used as a training mat)
 - 1 training jacket
 - 1 charger with international plug adapters
 - 12 AED pad adapters
 - Instructor ID Card
- The different article numbers and options can be found in the table on the right.

	incl. tablet	Dark skin color
1022237		
1022244		X
1022071	X	
1022241	X	X



Note:

The CPRLilly PRO+ is delivered assembled and is ready to use. For the use of the feedback unit and operation in a network, only a few initial setup steps are necessary. For this, see the section entitled "Training".



Tip:

Before using it for the first time, we recommend fully charging the battery of the CPRLilly PRO+ in order to achieve the maximum operating time.



> QUICK GUIDE TO CHANGING THE VENTILATION UNIT

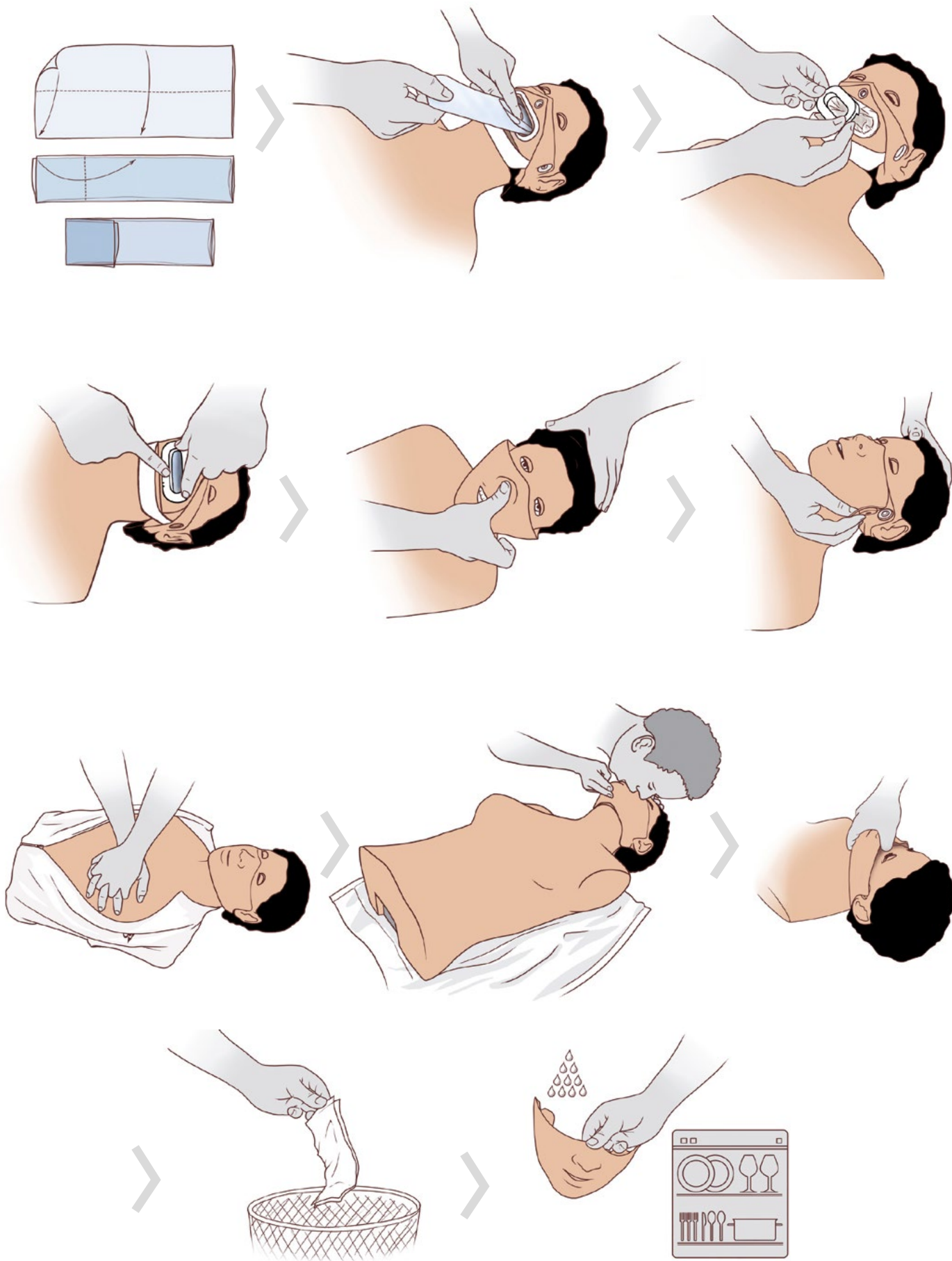

> STARTUP



Tip: Even with a dead battery, you can conduct a course if a power connection is available! To do this, connect the power supply to the CPRLilly PRO+. When not in use for an extended period of time, make sure that the CPRLilly PRO+ is charged at least every 6 months so that the battery is not permanently damaged by a deep discharge. Therefore, before planned extended periods of non-use, please charge the battery fully until the LED-illuminated switch flashes 3 times in quick succession, and then disconnect the plug connection as a precaution.

Switching on and off

The CPRLilly PRO+ is supplied with 15 volts via the small appliance socket. The scope of delivery includes a worldwide usable multi-voltage power supply unit with exchangeable plug adapters for operation in more than 150 countries. The voltage can be between 100 and 240 volts at a supply frequency of 50 or 60 Hz. We recommend that you always charge the CPRLilly PRO+ with the included power pack. The battery is full when the LED-illuminated switch flashes 3 times in quick succession.

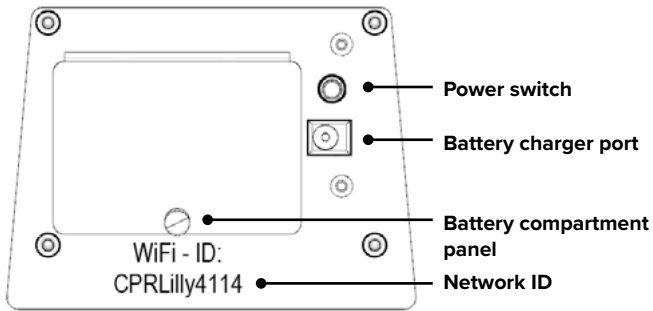

To switch on the CPRLilly PRO+, press the LED-illuminated switch briefly. The switch-on process is indicated by an immediate illumination of the green LED-illuminated switch.

Assembly and use



Note: To prevent moisture from entering the inner circulation, ventilation should only be carried out with a disposable throat bag. The throat bag must not be replaced in a moist environment; otherwise, moisture could enter the inner circulation and damage the CPRLilly PRO+.



Tip: The Quick Guide provides a quick and intuitive way to handle the CPRLilly PRO+ thanks to the clear illustrations. It is recommended that the Quick Guide be printed out on full pages and attached to the simulator.

The CPRLilly PRO+ is delivered with a disposable throat bag and a face mask already in place. Additional disposable throat bags (25 pcs.) and face masks (3 pcs.) are included. Be sure to practice the steps for correctly changing the different inserts before conducting a training session or a test process for the first time. To ensure the highest level of hygienic safety, a new disposable throat bag and a fresh face mask should be used for each person being trained.

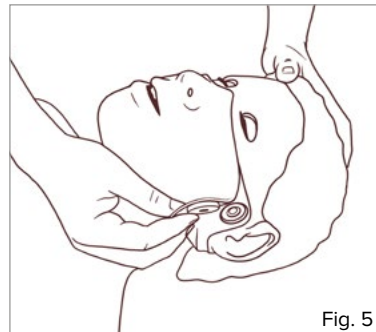

1. To remove the face mask, first release the magnetic connections next to the ears and fold back the cheek skin.



2. Now insert your thumb behind the face mask, between the bridge of the nose and the forehead to expose the hidden push button connection (pry it out). Pull the face mask forward from the face. You now have access to the throat opening.

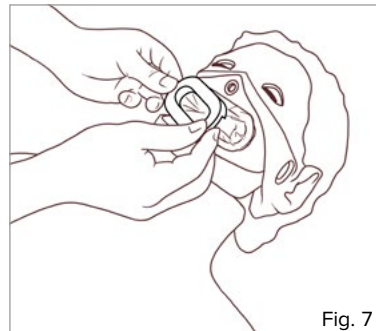

3. Remove the throat bag clip from the pharynx opening. Reach behind the side recess of the cover with the index and middle finger and pry it off. The disposable throat bag can now be removed and disposed of.

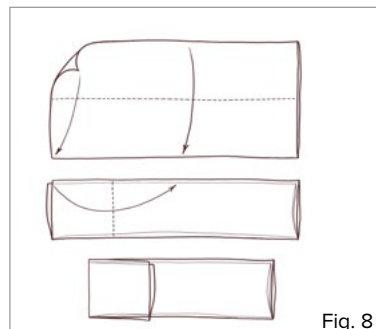

4. Before inserting a new disposable throat bag, fold it once in the middle lengthwise, as shown in the instructions, and then again along the lower third (with the opening facing away) crosswise to the first fold.

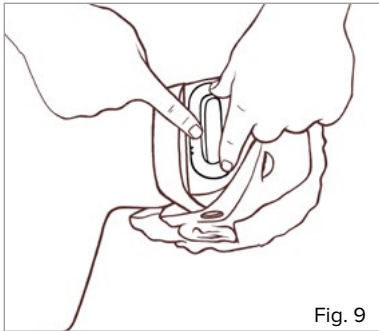

Fig. 9

5. Insert the disposable throat bag with the folded underside first into the throat opening. Place the open end around the throat opening. Firmly press the bag clip onto the collar of the throat opening so that the disposable throat bag is fully pressed in and therefore sealed. When the bag clip is correctly inserted, it can be heard snapping into place.

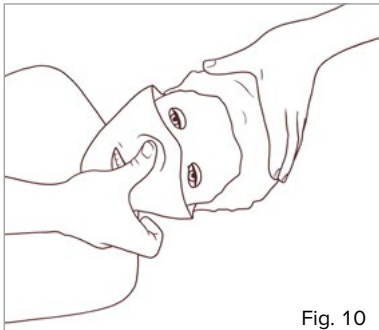

Fig. 10

6. Now secure the face mask with the chin part over the lower jaw bracket (white) and push the tooth insert into the throat opening as far as it will go. Press firmly on the tip of the nose (towards the bridge of the nose) with your thumb until you hear a clear "click".

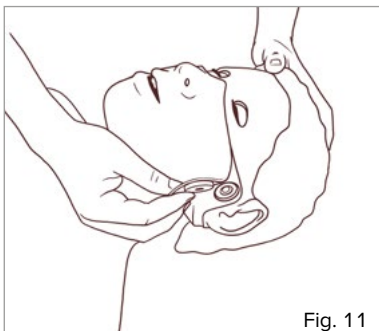
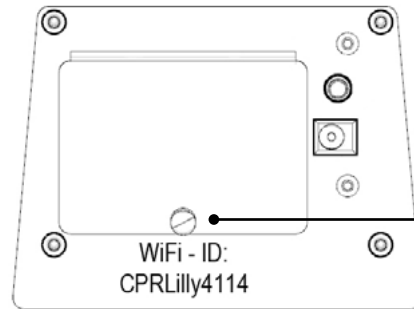

Fig. 11

7. Close the magnetic connections. The CPRLilly PRO+ is now ready for use again.

Battery replacement

The CPRLilly PRO+ has a long-lasting lithium ion battery with a very low self-discharge. Should it still be necessary to replace the battery, this can be done easily and quickly.



Battery compartment panel

Fig. 12

1. Unlock the securing pin of the battery compartment cover (black) by pulling gently, and remove the cover. You now have access to the battery and can pull it out of the battery compartment.



Fig. 13

2. Carefully pull on the fabric tape until the battery is accessible, then remove the battery. Always pay attention to the cable connections when doing this.

3. Change the plug connection from the old to the new replacement battery and push it back into the battery compartment until it stops, with the cable connection (right-hand side) at the front.

4. Stow the end of the fabric strap in the battery compartment and close the latter with the battery compartment cover. Lock the securing pin by pressing lightly.

> TRAINING

1. Downloading and starting the software application



Note:

After switching on the CPRLilly PRO+, always first establish a WLAN network connection between the simulator and the mobile device before starting the application. Using up to 10 CPRLilly PRO+ units in a network at the same time requires an additional "multi-manikin" router. The instructions for operating multiple devices can be found in the section "6. Network operation" and in "5. Logging in as a trainer".

To control and evaluate the CPR training session, you can use a mobile device of your choice. Either an iOS or Android operating system is required. The CPR feedback software (app) for the CPRLilly PRO+ can be downloaded free of charge in the corresponding app store. Relevant system requirements can be found in the description of the app store. Microsoft Edge, Google Chrome or Safari can be used in the browser. The app cannot be operated offline without connecting to the CPRLilly PRO+. Otherwise, only a grayed out login form will appear after starting the app. If a switched-on CPRLilly PRO+ is in range of the terminal, it will be displayed in the network settings. However, after switching on the CPRLilly PRO+, it may take up to 3 minutes until it is displayed on your terminal. The network connection shows the individual name of the CPRLilly PRO+ (CPRLilly xxxx – you will find the name below the battery compartment cover).

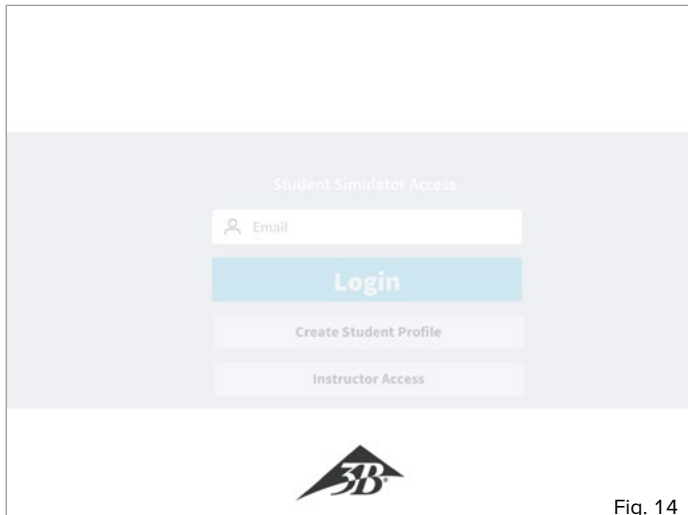

Fig. 14

• First connect your terminal to the available CPRLilly PRO+ units. If necessary, first activate the WLAN function of the terminal. The password is: "simadmin" and is identical for all CPRLilly PRO+ units.

• **Using a mobile device:** Launch the app by tapping the app icon on your device.

• **Using a desktop computer (browser variant):** Open the browser and enter the IP address "10.42.0.1" in the address field of the browser (confirm with "Enter" and switch to full-screen view (F10 shortcut key for Microsoft or key combination [Ctrl] + [Cmd] + [F] for Apple). **Attention:** When using a router-based network, the IP address of the router you are using must be entered. Please refer to the instructions under [6.1.1 Network operation when using desktop computers](#).

As soon as a connection is established (login form no longer grayed out), the registration process of the app can be started.

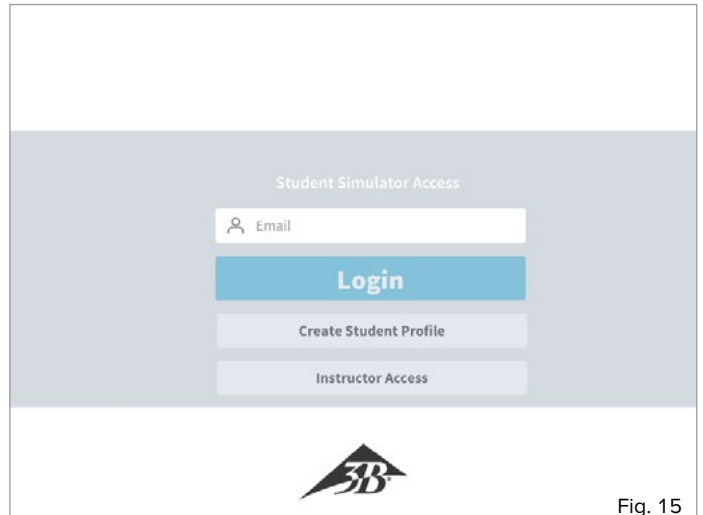

Fig. 15

• The login form always shows "Student Simulator Access" as the default setting, i.e. access as a trainee. If the trainee already has a user account ("Student Profile"), he or she can log in immediately. See instructions for ["4. Logging in as a trainee with a user account"](#). To create a "Student Profile," please select the button "Create Student Profile" and follow the instructions to ["2. Creation of a user account"](#)

CPRLilly PRO+

2. Creation of a user account ("Student Profile")



Note:

The user account is stored locally only and cannot be transferred to another CPRLilly PRO+. The selected device is the CPRLilly PRO+ with which the trainee must complete all training and examination processes. Alternatively, of course, another user account can be created on another CPRLilly PRO+.

A separate user account must be set up for each participant for the assignment of the CPR training and examination data. This user account and its data are stored locally on the operating system of the corresponding CPRLilly PRO+. There is no central storage of the data, and the local user account is irrevocably deleted after 7 days. After selecting the "Create Student Profile" button, a selection dialog box appears in which the corresponding CPRLilly PRO+ on which the local user account is to be stored must be selected.

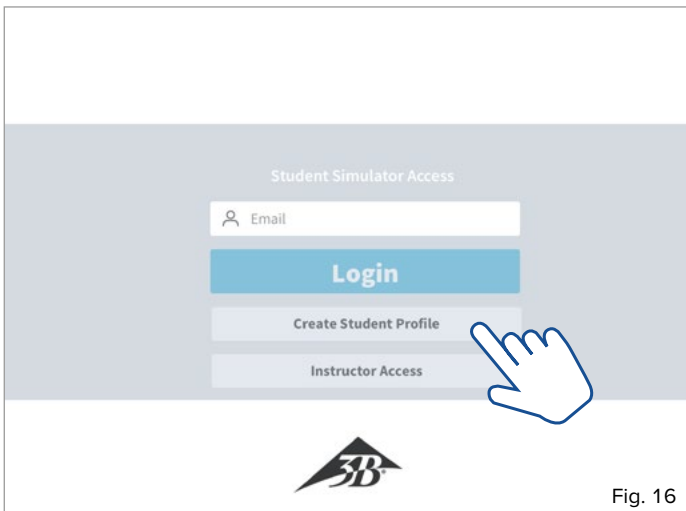

Fig. 16

1. Select the "Create Student Profile" button. A selection dialog box appears with the active devices (simulators) in range.

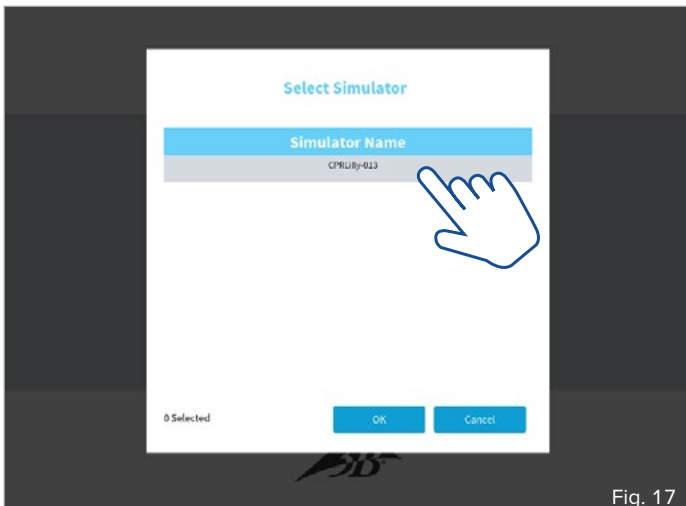

Fig. 17

2. Select the desired CPRLilly PRO+ by tapping on it. Confirm the selection with "OK." With "Cancel," you go back to the initial login form.

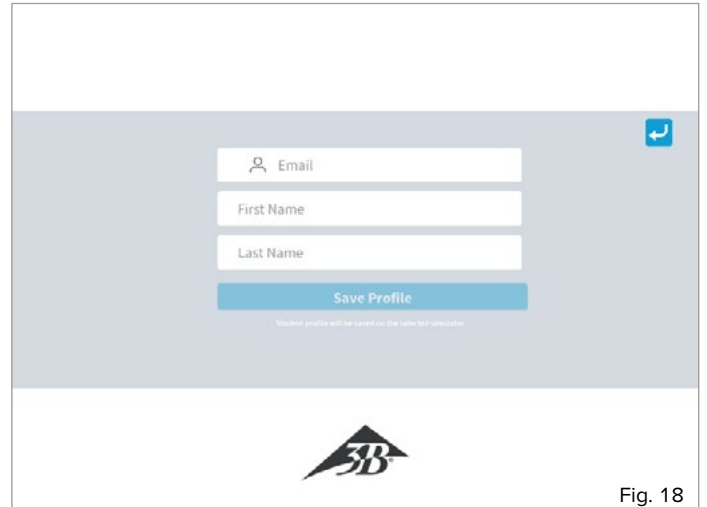
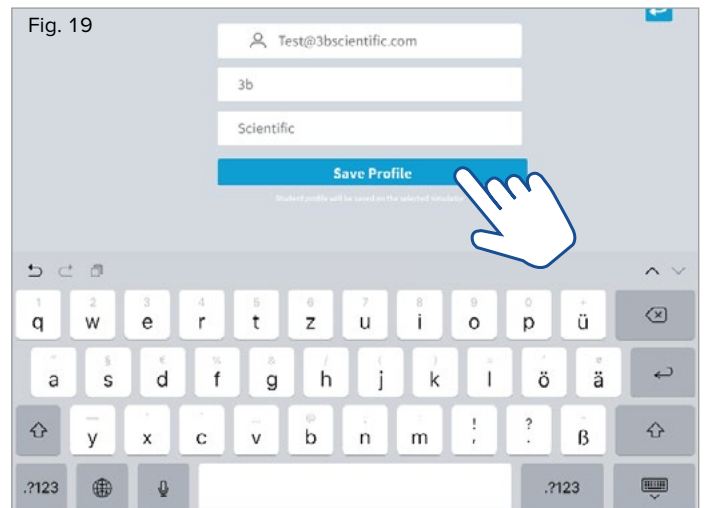

Fig. 18

3. Enter your email address and your first and last name in the appropriate input fields.



4. With "Save Profile," you confirm your input, and a user profile is created on the previously selected CPRLilly PRO+.

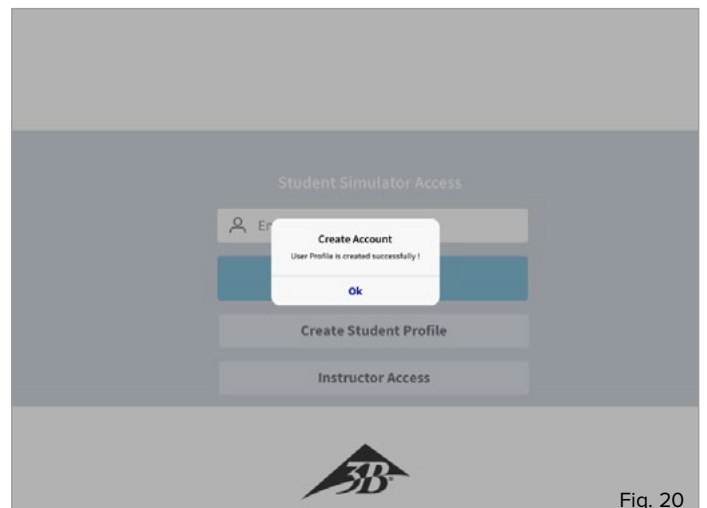

Fig. 20

5. The successful creation of your user account is confirmed by a dialog box. You can now log in according to the instructions "4. Logging in as a trainee with a user account."

3. General controls and icons



Note:

All important controls and icons of the software are shown and explained here. Use this section as a quick reference guide and for help getting started with the software. To use each application precisely, please follow the instructions in each section.

The controls of the software should be activated when using mobile devices via the touch-sensitive surface of the display by "tapping". The virtual keyboard and dialog boxes may have different designs depending on the operating system. When using the browser variant, the inputs are made via the corresponding input devices (mouse and keyboard).



Training: This icon will allow you to conduct training sessions in both Instructor and Student mode.

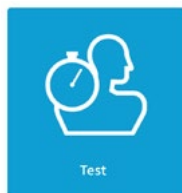

Test: This icon allows you to conduct test sessions in both Instructor and Student mode.



Monitor: This icon will take you to the Instructor Mode for an overview of all active training and test sessions. Starting training and test sessions is not possible in the "Monitor" segment; it is used to monitor and stop all activities.



Results: This icon will take you to the overview of all saved test logs in the Instructor Mode.



CPR instructions: Use this icon to view all major cardiopulmonary resuscitation steps in both Instructor and Student Modes.



Settings: Use this icon to access the available setting options and general notes in both Instructor and Student Mode.

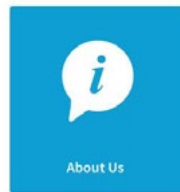

About us: This icon takes you, in both Instructor and Student Mode, to general notes on 3B Scientific.



Parameters: This icon will take you to the settings for the training and test parameters in Instructor Mode.



Languages and units: This icon allows you to access the operating language and device settings in both Instructor and Student Modes.



Network: This icon will take you to the network configuration in Instructor Mode.

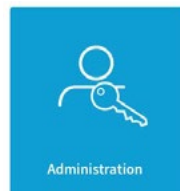

Administration: This icon allows you to upgrade the operating software in Instructor Mode, if necessary.



Select simulators: This icon allows you, in network operation, to add individual CPRLilly PRO+ units in Instructor Mode.

4. Logging in as a trainee with a user account ("Student Simulator Access")



Note:

Logging in as a trainee ("Student") always creates a connection to a single CPRLilly PRO+. However, another connection can be established by a trainer to this CPRLilly PRO+. The simultaneous coordination of several CPRLilly PRO+ units must always be managed via the "Instructor" access via the network. The instructions for operating multiple devices can be found in the section "6. Network operation" and in "5. Logging in as a trainer".

If you have already created a user account, you can log in immediately using the initial login form.

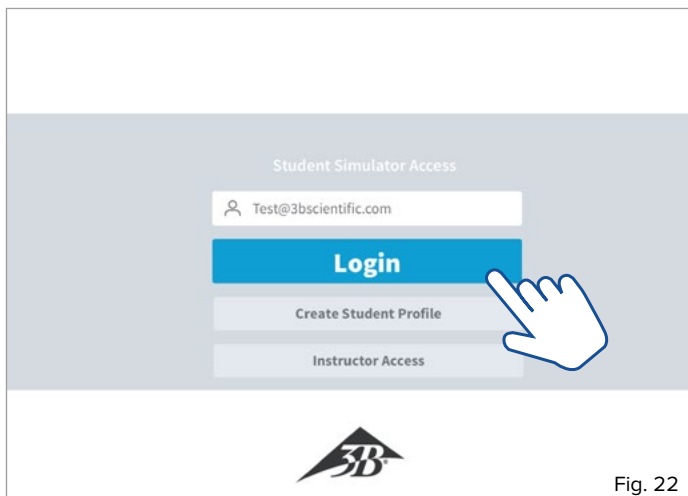

Fig. 22

- Enter the email address specified for the user account in the input field provided and press the "Login" selection key
- Select the desired CPRLilly PRO+ and confirm the selection with OK (only necessary in network mode and if a user account has been set up on more than one CPRLilly PRO+).

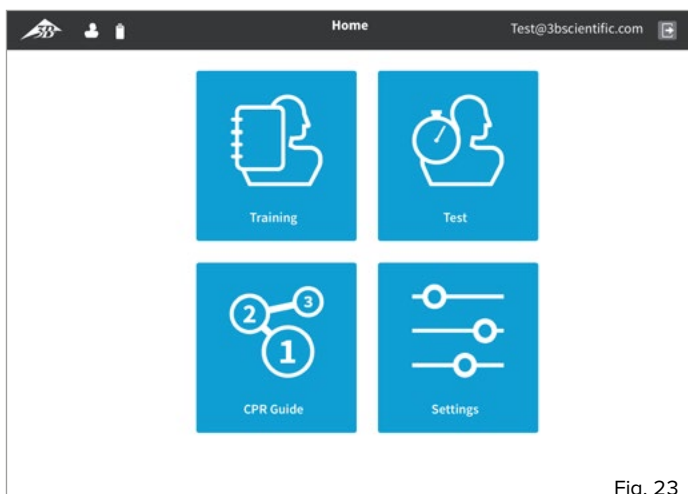

Fig. 23

- You are taken to the "Home Screen" of the application, from where you can select the different segments "Training", "Test", "CPR Guide" and "Settings"

4.1. Training



Tip: After an introductory explanation of the most important parameters of proper cardiopulmonary resuscitation by the trainer, the trainee can then train independently. Thanks to the intuitive feedback design, the trainee can achieve a fast learning curve and learn efficiently. The trainer can help the trainee by connecting to his or her CPRLilly PRO+.



Note: A training session can be started and stopped by the trainer or the trainee. If a training or test session is started by the trainee, it can no longer be managed by the trainer in the "Training" or "Test" segments. The trainer then has the opportunity to monitor and end all training or testing activities in the "Monitor" segment.

Attention: If a training session is stopped by the trainer, no log will be created and displayed for this training run! All training parameters can be individually adjusted, but the basic settings meet the requirements of valid AHA or ERC specifications. Changes can only be made by the trainer in the segment "5.6 Settings" -> "5.6.2 Parameters."

In the "Training" segment, the trainee has an intuitive feedback interface which provides direct feedback on all training parameters (see Figure 25 with reference lines). To achieve the most efficient learning curve, first get an overview of all displayed parameters. During an active training session, the hints from the feedback reports should be understood in order to allow intuitive correction behavior.

The feedback reports at a glance:

The screenshot shows a training interface with the following parameters and their descriptions:

- "Cycles":** Counts the CPR cycles (30:2); on the left are the correct cycles, on the right is the total number.
- "Time":** Shows the time elapsed since the beginning of the training session.
- "Compressions":** Shows not only the depth but also the release of individual chest compressions.
- "Hand Position":** Indicates whether the hand position for compression is correct.
- "AED":** Indicates whether the electrode pads of an AED have been correctly placed.
- "Counter":** Counts the individual compressions made ("Comp," above) and single breaths ("Breath," below).
- "Head tilt":** Indicates the tilt of the head during ventilation.
- "Frequency":** Displays the current average of the compression frequency.
- "Ventilation":** Displays the amount of ventilation air introduced.
- "Blood Flow":** Indicator of good (sufficient) compression performance.
- "Compression Fraction":** Shows relative proportion of compression time to total time.
- "Ventilation Fraction":** Shows relative proportion of ventilation time to total time.

Fig. 25

At the end of the training run, a log can be called up. An overview of the evaluation with a total result (score) and the note "Passed" or "Failed" can also be viewed. For a detailed description of the log, please refer to the section "5.4 Results."

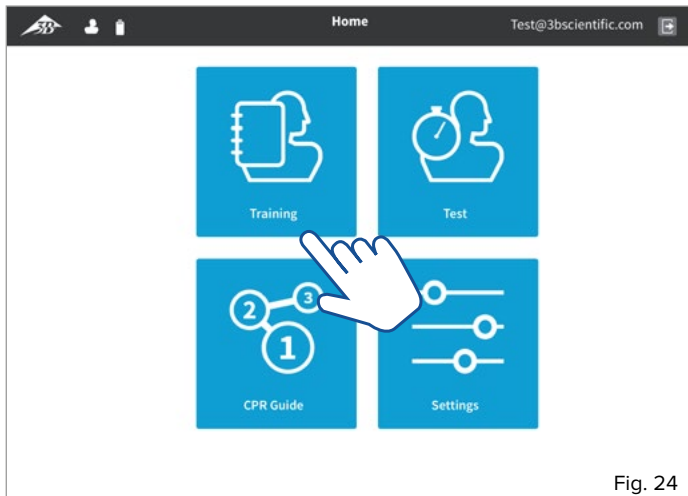



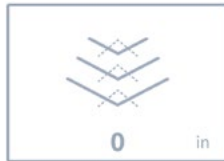

Fig. 24

- Start in the home screen (using the "back"  and "home"  buttons will always return you to the home screen). Select the **"Training"** segment by tapping the button.
- When you are ready to start the training session, press the Start button . The time counter starts and the training session is being recorded.

- The quality of the compressions is displayed in the **"Compressions"** field. At the correct compression depth, the downward arrowheads turn green. The respective compression depth is also displayed in the lower part of the field (cm or inches, depending on the setting). Correct release of the thorax after each compression is indicated by the upward (dotted) arrowheads. These, too, turn green with sufficient release.



- Change to ventilation after 30 compressions. To do this, use the head tilt-chin lift maneuver or, alternatively, the jaw-thrust maneuver. If done correctly, the **"Head tilt"** field turns green.



- Ventilate mouth-to-mouth or mouth-to-nose or by using an appropriate bag valve mask.

- The quality of the ventilation is displayed in the **"Ventilation"** field. If the ventilation volume is correct, both lungs will turn green. If the ventilation volume is too low, the inner lines of the lungs turn red, and if the volume is too high, the outer lines turn red. The respective volume is also displayed in the lower part of the field (ml).



- The number of compressions and ventilations within a resuscitation cycle are displayed in the **"Counter"** field. The total number of cycles performed is shown in the **"Cycles"** field.

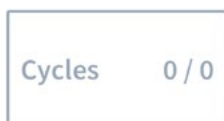

- The **"Compression Fraction"** and **"Ventilation Fraction"** show the relative proportions of each activity to the total time. In order to carry out a resuscitation as efficiently as possible, "dead times" (action-free times without compression or ventilation) are to be avoided as much as possible.

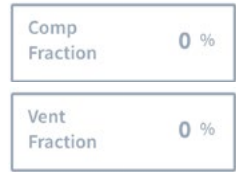

- End the training at any time by pressing the stop button .

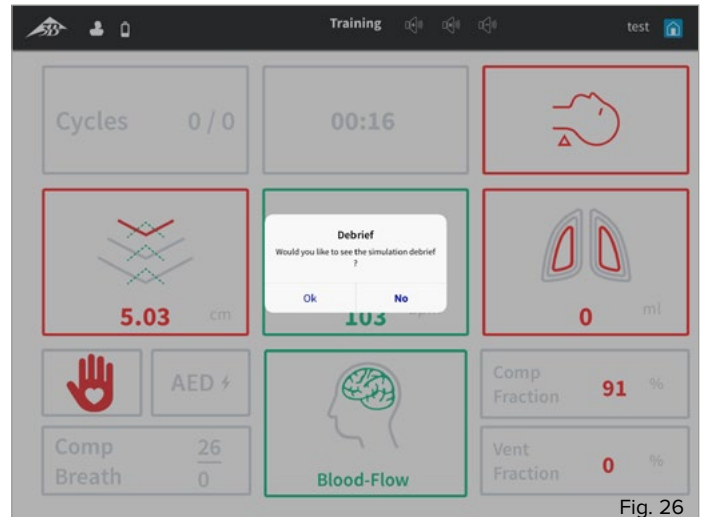

Fig. 26

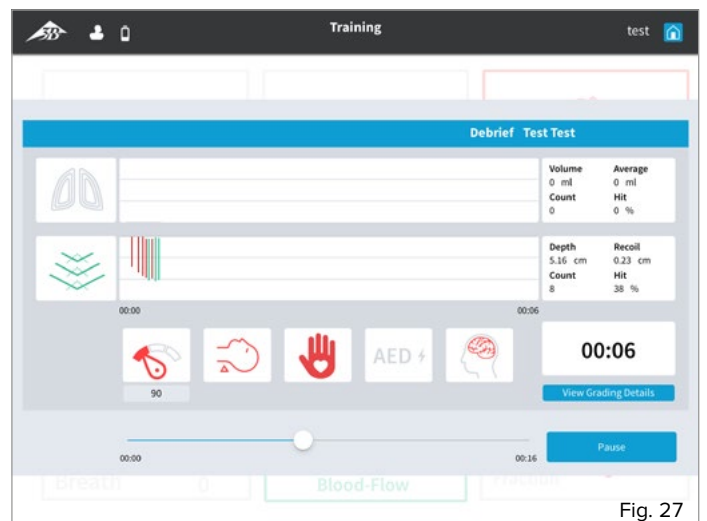

Fig. 27



Note:

In addition to the software-based feedback display, 3 additional red LED lights in the neck area (under the skin, transparent) provide simplified feedback on the quality of the resuscitation.

- 1 LED light: Compressions are being conducted
- 2 LED lights: Compressions are being conducted at the correct depth and at almost the right frequency
- 3 LED lights: Compressions are being conducted at the correct depth and correct frequency. The carotid pulse can also be detected at this stage. If compression quality drops, this disappears again; if compressions are stopped, the carotid pulse can be felt for another 20 seconds.

4.2 Test



Note:

The trainee can take a test session himself, and an evaluation log will be produced upon completion. However, a test certificate can only be issued by the trainer. For this, the test session must also be started by the trainer (see 5.2 Test.).

If the trainee starts a test session, the view of the feedback display and the process are no different from a training session. However, unlike a training session, after completion of a test session, a result log is saved. This is visible to the trainer only for a certain period (7 days, as long as the account is available).

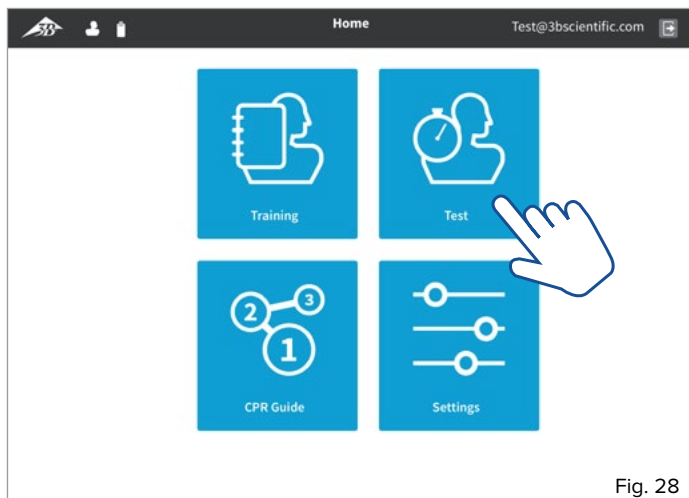

Fig. 28

- Start in the home screen (using the "back" and "home" buttons will always return you to the home screen). Select the **"Test"** segment by tapping the button.
- When you are ready to start the test, press the Start button . The time counter starts and the test session is being recorded.
- Now proceed as described under "4.1 Training."

4.3 CPR Guide



Note:

Using the CPR Guide, the trainee can always look up and independently deepen his or her knowledge of all the important steps of the entire resuscitation procedure. The CPR Guide is intended as a software-based learning aid and does not replace detailed instruction by qualified trainers.

The "CPR Guide" segment can be accessed before or after the training or test session. All the necessary steps can, therefore, be effectively memorized.

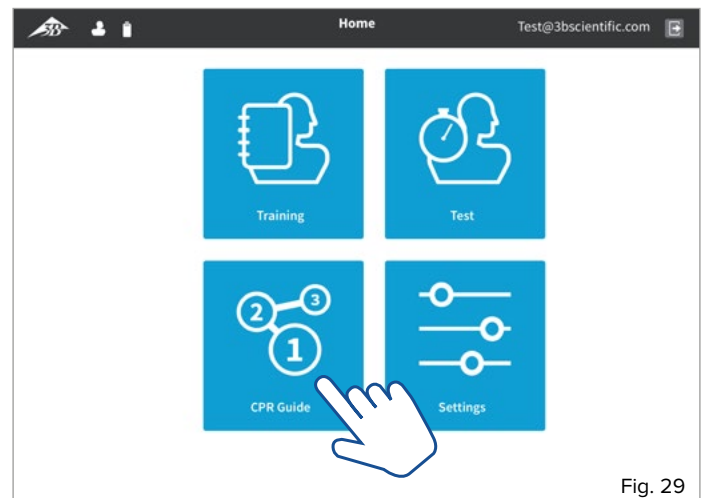

Fig. 29

- Start in the home screen (using the "back" and "home" buttons will always return you to the home screen). Select the **"CPR Guide"** segment by tapping the button.
- By selecting the "Next" and "Previous" buttons, you can navigate through the individual steps of the CPR Guide. Or select a specific page by tapping the corresponding number in the step overview.

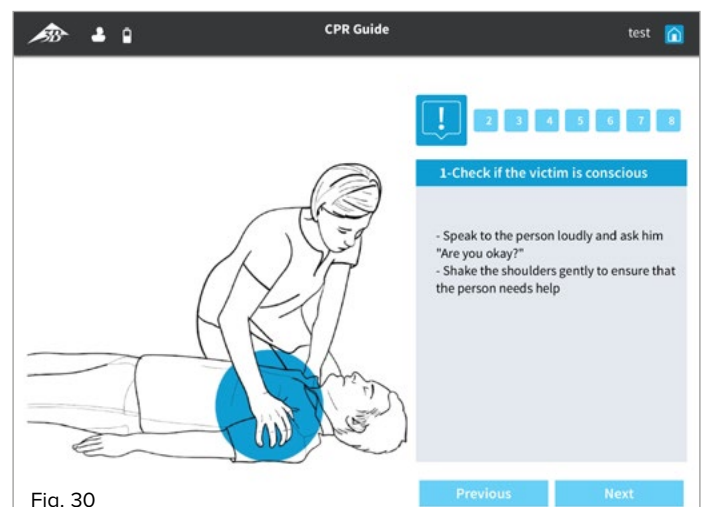

Fig. 30

- Use the "home" button to return to the home screen.

4.4 Settings

As a trainee you have the option of setting the operating language and the standard units. In addition, general information about the software and the related guidelines can be found in the section "5.6.1 About us."

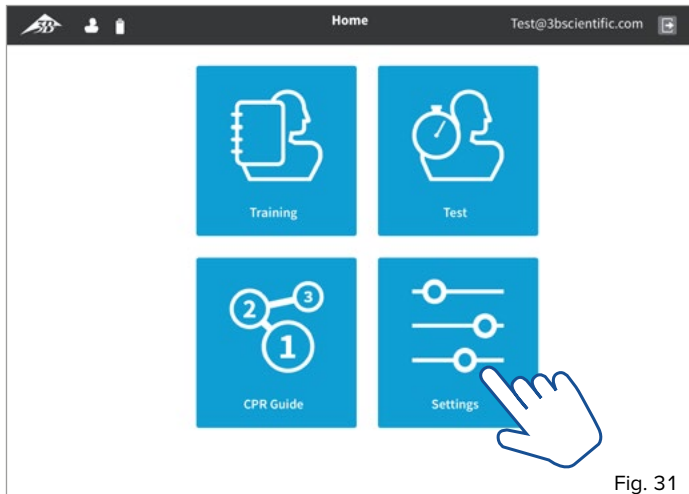

Fig. 31

- Start in the home screen (using the "back" and "home" buttons will always return you to the home screen). Select the **"Settings"** segment by tapping the button.

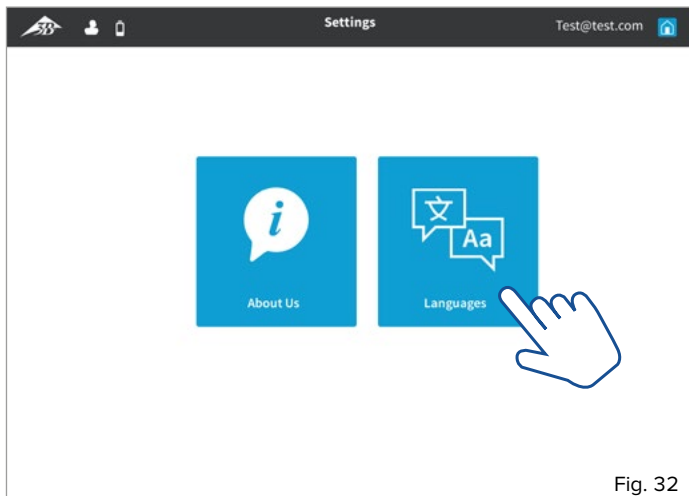

Fig. 32

- To select the language and unit settings, select the **"Languages"** section by tapping the button.



Fig. 33

- In the left pane, select your desired language by tapping the button.
- In the right pane you can choose between the metric and imperial unit system. Select the desired unit system by tapping.
- Use the "home" button to return to the home screen.



Note:

Logging in as an "Instructor" not only offers a vastly expanded range of choices, but primarily allows for the control and monitoring of the training and testing units. So, access should be reserved for technically trained trainers only. Protection against improper modification of testing parameters or unjustified issuance of certificates is ensured by the password-protected access.

The "Instructor ID" and the "Password" can be found on the supplied "Instructor ID Card"



5. Logging in as a trainer ("Instructor Access")



Tip:

As the trainer in charge, give the trainee clear instructions on how to use the software application. The training and test runs can be coordinated most clearly when they are started and controlled by the trainer.

To log in as a trainer, please use the "Instructor ID" and "Password" provided.

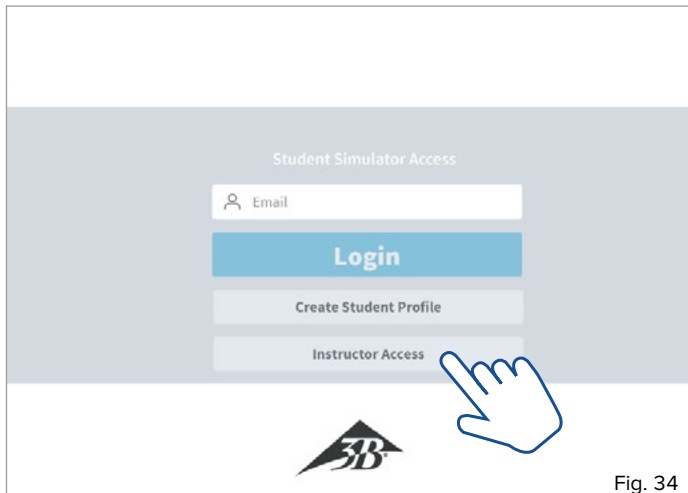

Fig. 34

- Select the **"Instructor Access"** button by tapping. An additional, detailed input screen appears.

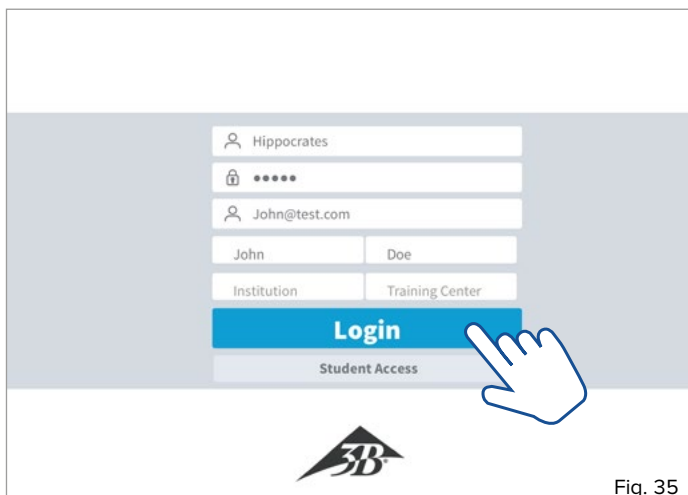

Fig. 35

- Enter the provided **"Instructor ID"** and the **"Password"**. Complete the form with your personal data and click on the **"Login"** button.
- A selection dialog box appears with the active devices in range.
- Select the desired CPRLilly PRO+ by tapping (multiple selection possible in network mode).
- Confirm the selection with "OK"; tapping "Cancel" takes you back to the initial login screen.

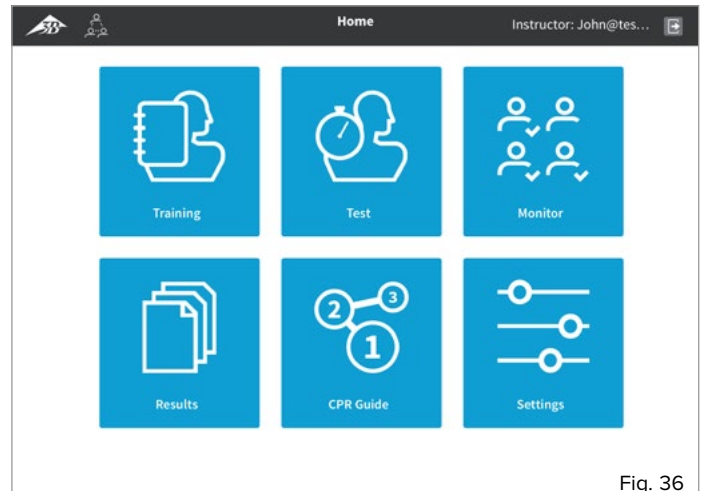

Fig. 36

- You can get to the "Home Screen" of the application, from which you can select the different segments "Training", "Test", "Monitor", "Results", "CPR Guide" and "Settings".

5.1 Training



Note:

Much of the way the parameters of a training session work and are shown is like the "Student" version. However, up to 10 CPRLilly PRO+ units can be monitored and controlled simultaneously in the "Instructor" version. To do this, however, the setup of a separate network (for instructions, see "6. Network operation") is necessary.



Tip:

We recommend the "Student" version for individual training as it looks clearer and more intuitive for the trainee. In addition, there is no training log available for a training session in the "Instructor" version. In this case, use an additional mobile device with the "Student" version, or switch from the "Instructor" version to the "Student" version on the mobile device in use (see instructions under "4. Logging in as a trainee")

The views of the "Instructor" version differ from those of the "Student" version because it is possible (via network mode) to monitor several models simultaneously. Even in stand-alone operation (hotspot mode), the term "group session" is used, but only one CPRLilly PRO+ can be monitored and controlled at a time.

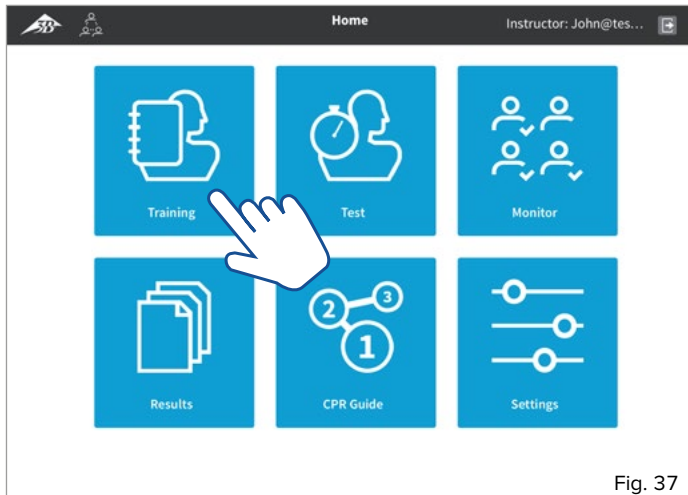

Fig. 37

- Start in the home screen (using the "back" and "home" buttons will always return you to the home screen). Select the "**Training**" segment by tapping the button. The message "Initializing Simulators ..." and a dialog box prompting the setup of a group session will appear.

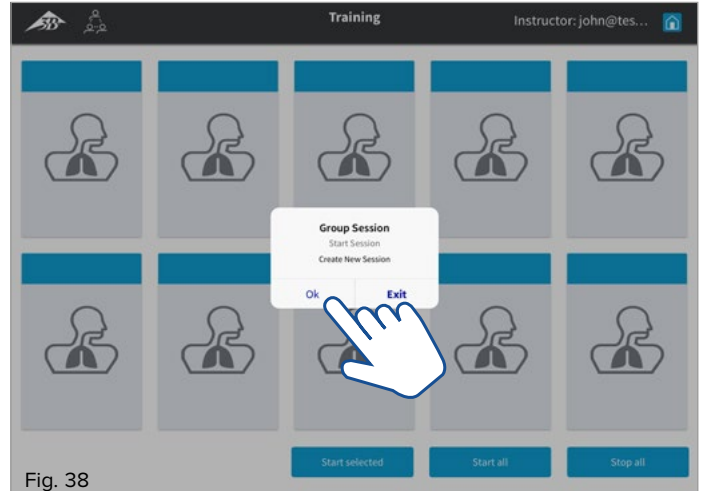

Fig. 38

- Confirm the dialog with OK. Use Exit to go back to the home screen. All available devices appear with their identification in the overview (Only one device is available in hotspot mode! – if you want to add several devices, switch to network mode (see instructions under "6. Network operation"))).

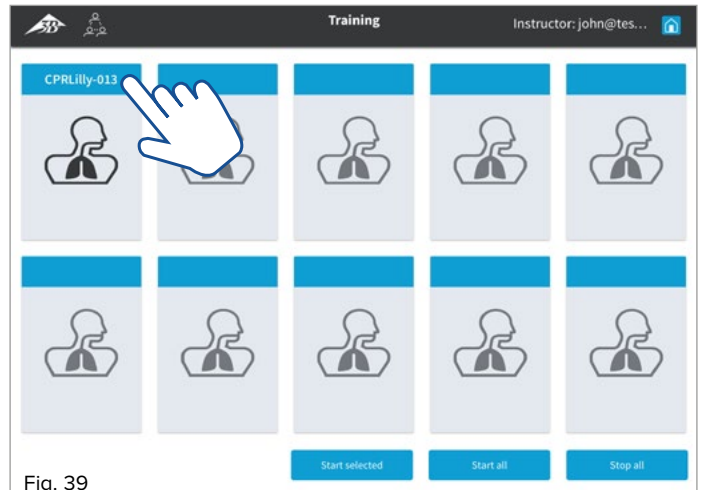

Fig. 39

- Assign the desired CPRLilly PRO+ to a trainee by tapping on the corresponding button. A drop-down dialog box will appear listing all previously registered trainees (If the trainee is not on the list, proceed according to the instructions in "2. Creating a user account").

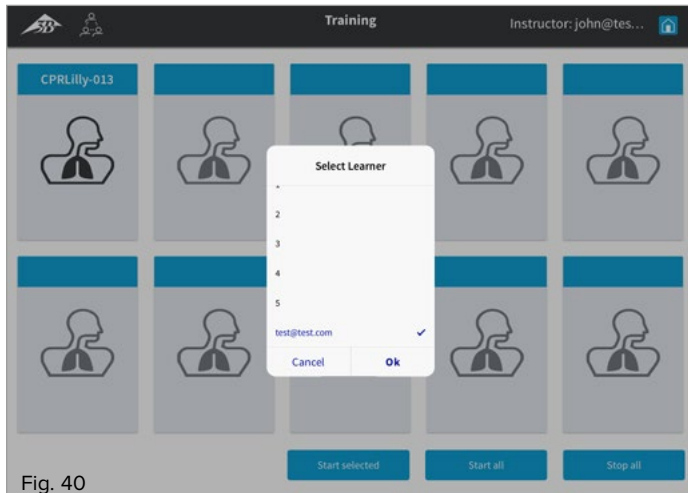

Fig. 40

- Select the trainee by tapping and confirm with "OK". The identification of the device changes to the name of the trainee. Use "Cancel" to go back to the overview.

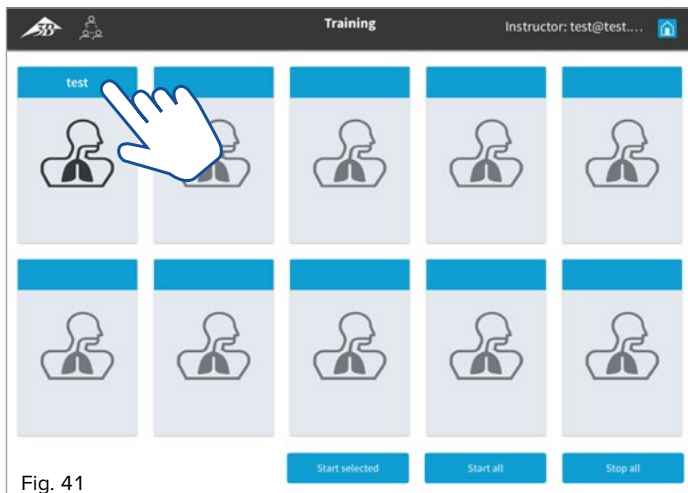

Fig. 41

- Select the button again by tapping. A tick indicates the selection made (In network mode, multiple selection is possible)

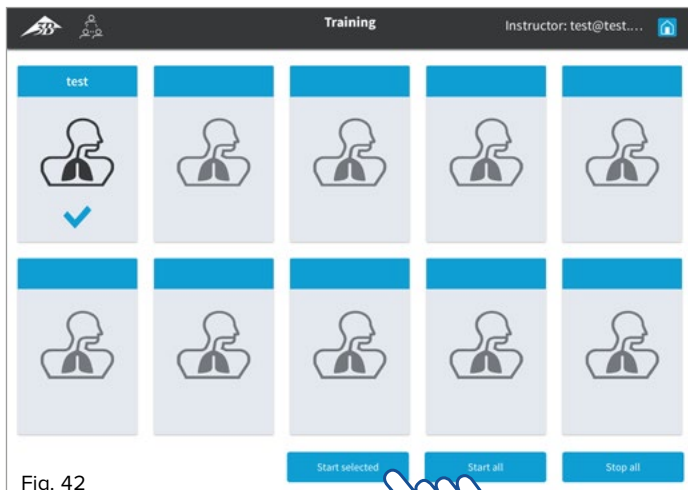

Fig. 42

- Start the training with "Start selected" or "Start all" (with multiple selection). The icon of the selected CPRLilly PRO+ changes to an active training overview (pie chart)

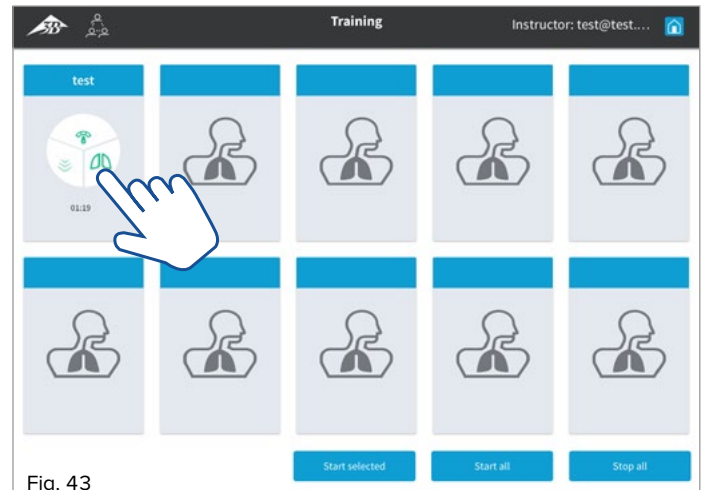

Fig. 43

- Switch to a detailed view of the training session by tapping the corresponding button again. The detail view of the individual CPRLilly PRO+ also displays the other available devices of the group training session as a simplified overview (pie chart) in the header, and they can be directly selected from there.

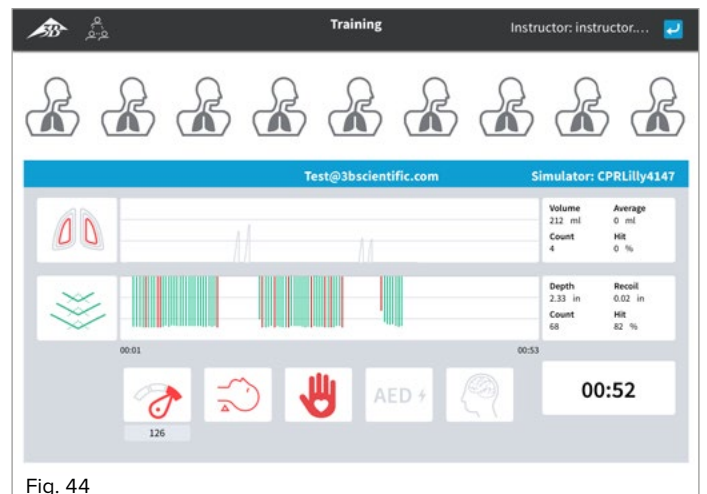

Fig. 44

- Use the "Back" button to return to the overview.
- Trainees can connect to the appropriate CPRLilly PRO+ at the same time using the "Student" version and gain feedback about their training session by selecting the "Training" segment.
- End the training session by tapping the "Stop all" button.
- Use the "home" button to return to the home screen.

5.2 Test





Note:

The sequence and display of the parameters of a test session are the same as those of the training session. In addition, the entire run is recorded as a log and stored for discussion afterwards. The feedback screen of the trainee ("Student" version) is locked, ensuring an authentic test result.

With a separately setup network (for instructions see "6. Network operation"), up to 10 CPRLilly PRO+ units can be monitored and controlled simultaneously in a test session with the Instructor version.



Fig. 45

- Start in the home screen (using the "back"  and "home"  buttons will always return you to the home screen). Select the "Test" segment by tapping the button. The message "Initializing Simulators ..." and a dialog box prompting the setup of a group session will appear.

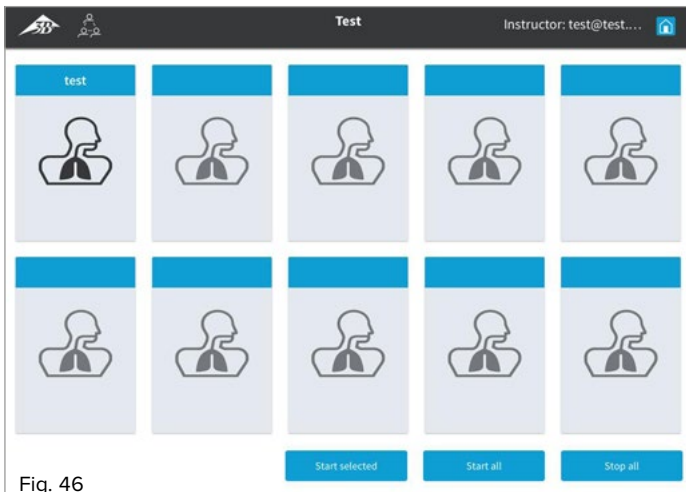

Fig. 46

- Confirm the dialog with OK. Use Exit to go back to the home screen. All available devices appear with their identification in the overview (Only one device is available in hotspot mode! - If you want to add several devices, switch to network mode (see instructions under "6. Network operation").

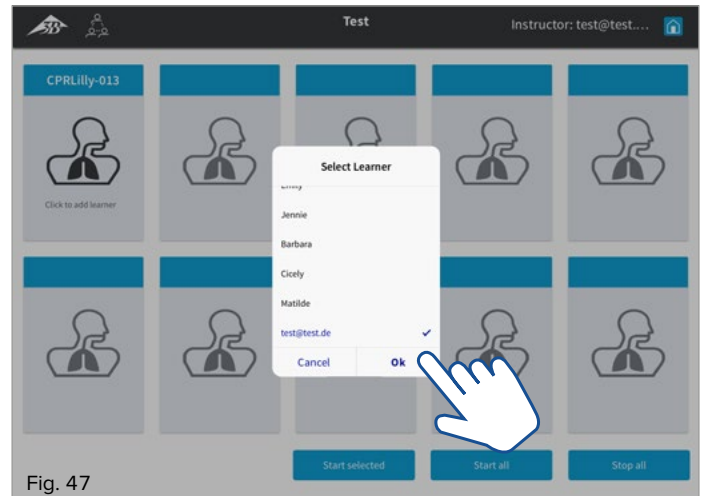

Fig. 47

- Assign a trainee to the desired CPRLilly PRO+ by tapping the corresponding button. A drop-down dialog box will appear listing all previously registered trainees (If the trainee is not in the list, follow the instructions in "2. Creating a user account").

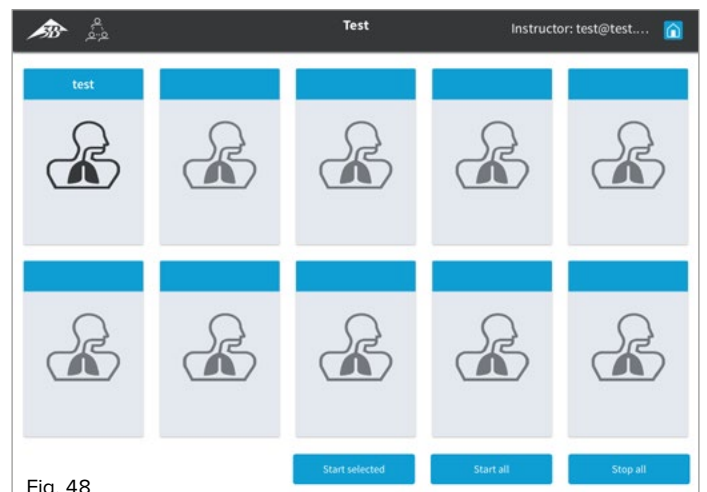

Fig. 48

- Select the trainee by tapping and confirm with OK. The identification of the device changes to the name of the trainee. Use "Cancel" to go back to the overview.

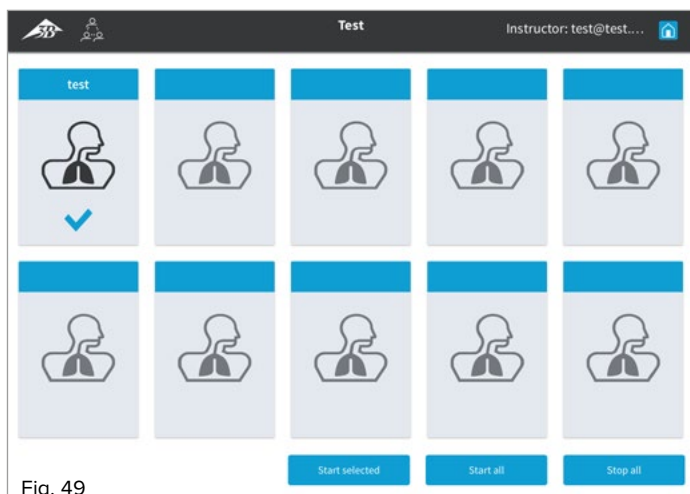

Fig. 49

- Select the button again by tapping. A tick indicates the selection made (In network mode, multiple selection is possible)

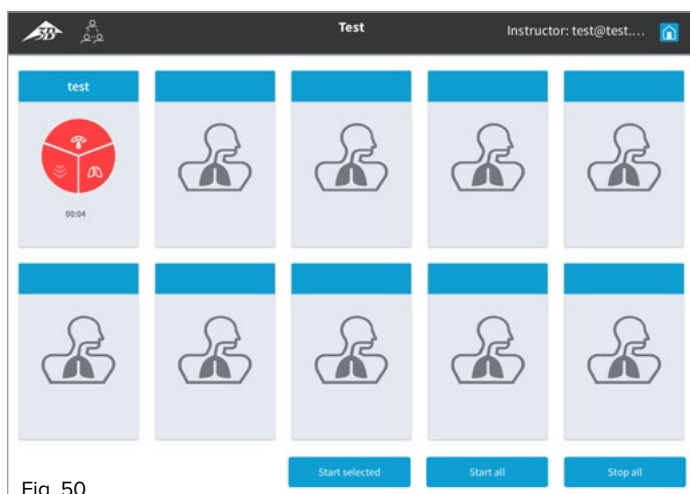

Fig. 50

- Start the test with "Start selected" or "Start all" (for multiple selection). The icon of the selected CPRLilly PRO+ changes to an active test overview (pie chart)

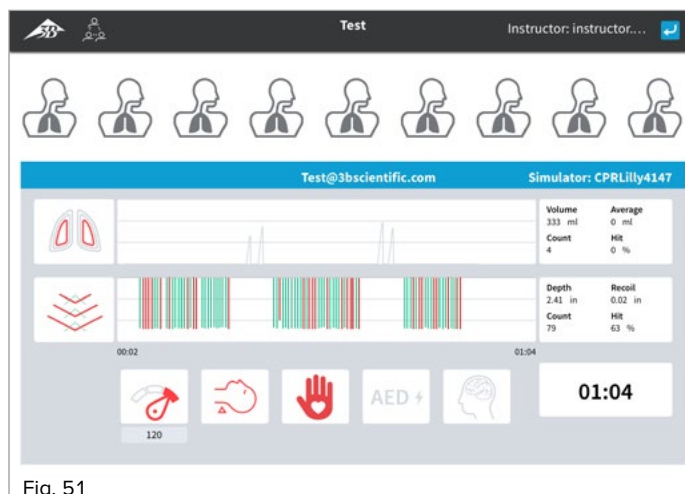

Fig. 51

- Switch to a detailed view of the test session by tapping the corresponding button again. The detail view of individual CPRLilly PRO+ also displays the other available devices of the group test session in a simplified overview (pie chart) in the header, and they can be directly selected from there.
- Use the "Back" button to return to the overview.
- Use the "home" button to return to the home screen.

5.3 Monitor



Tip:
The "Monitor" section is the best way to survey and control all the different activities of the trainees.



Note:
Starting training and test sessions is not possible in the "Monitor" segment; it is used to monitor and stop all activities.

In the "Monitor View" both training and test runs can be monitored in parallel in stand-alone or group operation. The trainees are assigned to the individual simulators depending on whether it is for the "Training" or the "Test" section.

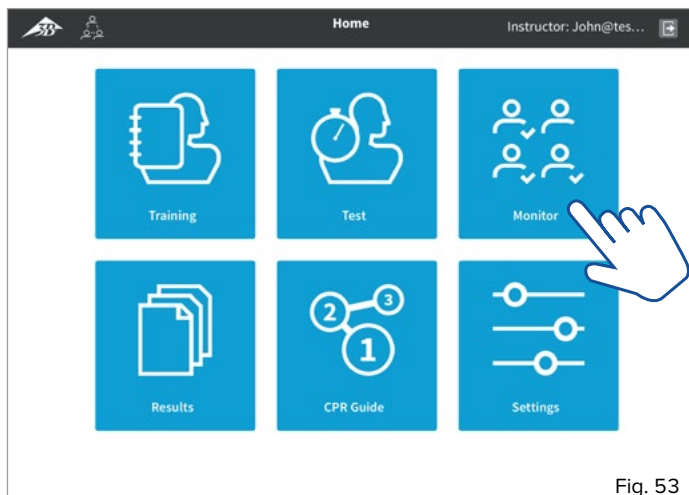

Fig. 53

- Start in the home screen (using the "back" and "home" buttons will always return you to the home screen). Select the "Monitor" segment by tapping the button. The message "Initializing Simulators ..." appears.

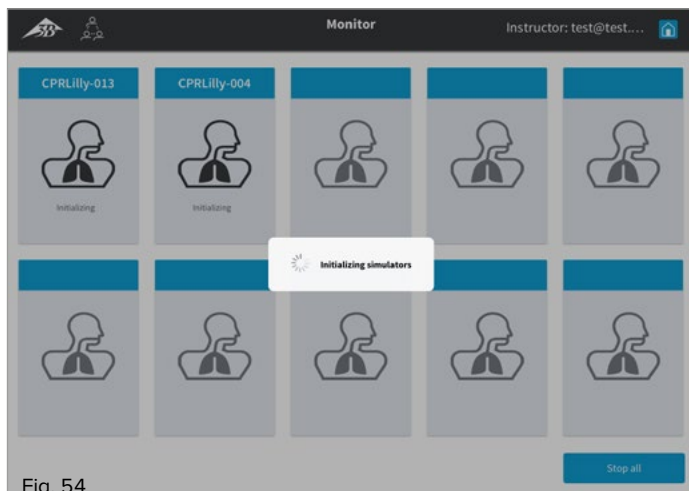

Fig. 54

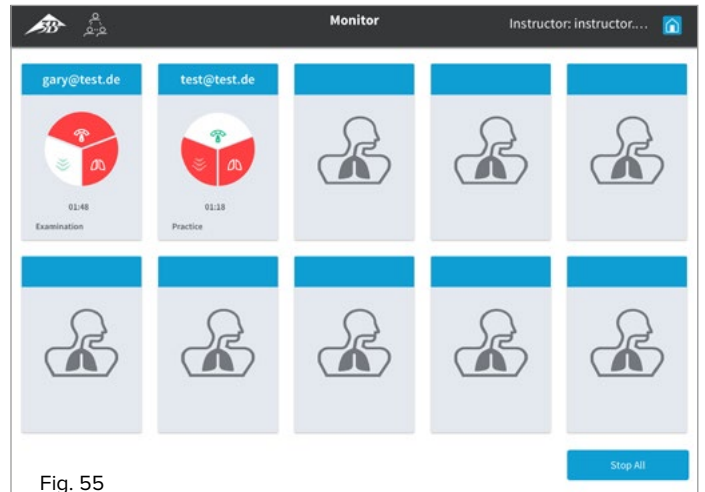

Fig. 55

- The current sessions of the trainees are displayed with a simplified overview, as a pie chart indicating the type of session (training, group session, test, group examination).

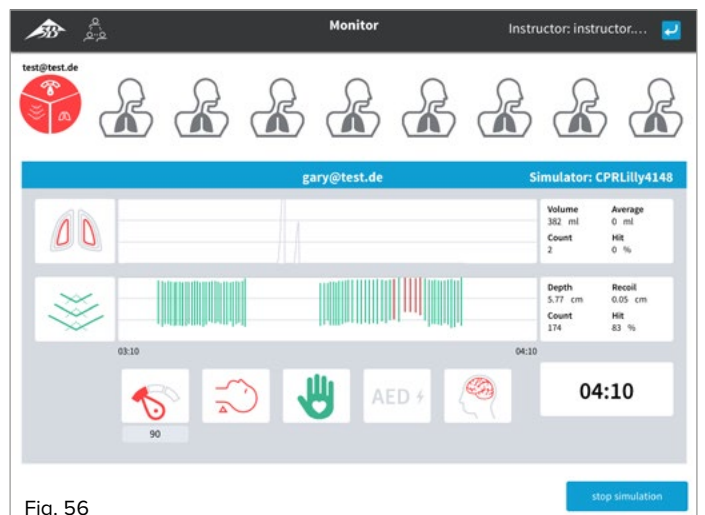

Fig. 56

- Tap the individual areas to go to the detail view of the current session. By tapping the "Stop Simulation" button, you can end the individually selected session.
- Use the "Back" button to return to the overview
- Press the "Stop all" button by tapping to end all current sessions at the same time.
- In the individual dialog boxes, confirm the termination of the sessions with "OK" again.
- The "home" button takes you to the home screen.

5.4 Results



Note:

The software provides automatic performance control. If all set parameter limits are adhered to, each test session is completed with a "Passed" rating. If the required values are not achieved, the test session is considered "Failed" and is not passed. The assessment is based on the overall score ("Score"), which is determined by an evaluation algorithm (see the table "Evaluation criteria" on the following page).



Tip:

To pass the training session despite insufficient performance, either the performance limit can be adjusted via the parameter settings (see instructions under "5.6.2 Parameters"), or a failed training session can be subsequently overwritten with "Passed" (see instructions under "5.2 Test").

All test sessions are automatically saved as a log. For an overview, each log is listed as an entry in a table with the most important details. The respective log can be identified by the name of the trainee and the corresponding date stamp (DD/MM/YYYY). However, the logs can also be called up and reproduced individually, as a complete record of the session. The data for the logs are stored in the memory of the respective CPRLilly PRO+ and can only be accessed by the trainer. The date of the log depends on the current settings of the mobile device on which the application was started. Please make sure the date settings are correct.

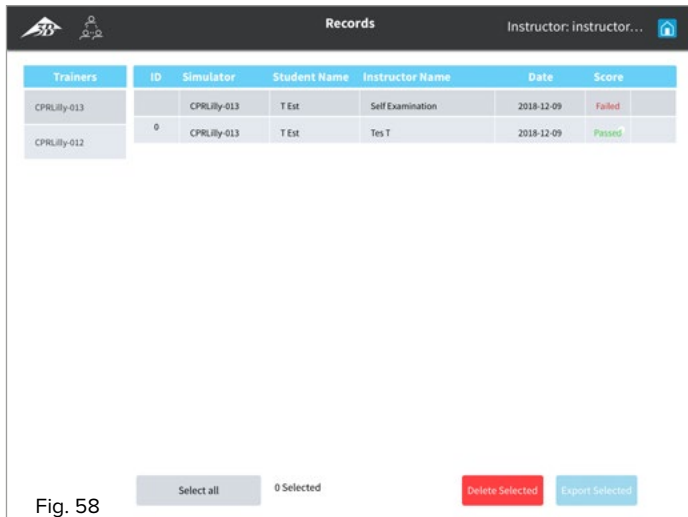

- Start in the home screen (using the "back" and "home" buttons will always return you to the home screen). Select the "Results" segment by tapping the button.
- The table lists all the saved training logs of the connected CPRLilly PRO+.
- First select the desired CPRLilly PRO+ from the "Trainers" column by tapping.

- Select the desired training log by tapping the appropriate line (any cell). The selected line is highlighted in blue, and a "Play" icon appears in the far right column. **Attention:** Multiple selection is not possible with the detailed view of a training log. So make sure that only one line of the table is marked (otherwise, no "Play" icon will appear).
- Tap on the "Play" icon to open the training log.

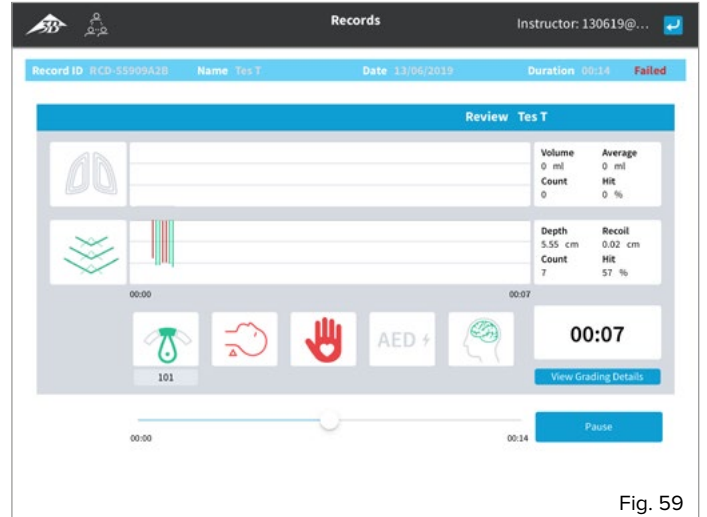

- Start the training log by tapping the "Play" button. Navigate freely through the log by moving the slider on the time bar.
- By tapping the "Pause" button, you can pause the training log while it is scrolling.
- Tap the "View Grading Details" button to see the final score based on the "Score" values. The slider has no function in the "Grading Details" view. The evaluation criteria for the Total Score can be found in the "Evaluation criteria" box.

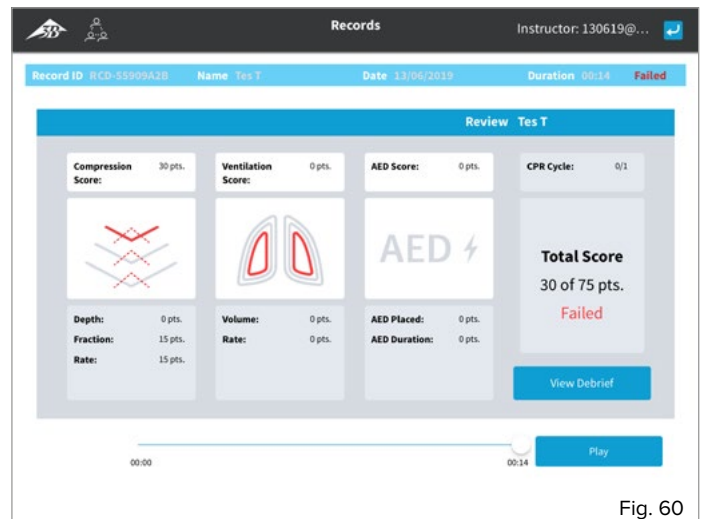

- Tap the "View Debrief" button to return to the training log. Alternatively, you can also jump back to the overview via the Back button.
- Use the "home" button to return to the home screen.

5.4 Results – evaluation criteria (score)

	Parameters	Value	Score (pts.)	Max (pts.)	Pass (pts.)	Auto Fail
Compressions				45	35	
	Correct Depth (and Recoil)	80% of the time	15	15		YES
		<80% of the time	0			
	Compression Fraction	>=60%	15			
		<60%	0			
	Compression Frequency (average)	100-120	15			
		90-99	5			
<90		0				
Ventilations				15	10	
	Correct Volume	>= 75 % of the time	5	10		
		<75% of the time	0			
	Ventilation Rate (per min)	>5	10			
		4	5			
		<4	0			
AED				10	0	
	Correct Placement	yes	5	5		
		no	0			
	Timing	<= 2 min	5			
		> 2 min	0			
Total Score				70	45	

5.5 CPR Guide



Note:
See explanation "4.3 CPR Guide"

5.6 Settings



Note:

In the "Settings" area, in addition to software-specific settings, the relevant parameters can also be individually adjusted according to the guidelines for resuscitation (see "5.6.2 Parameters").

The number of individual settings is significantly higher for the "Instructor" version compared to the "Student" version. Some settings only apply to the currently selected CPRLilly PRO+, while others refer to the personal mobile device. In the settings that affect each CPRLilly PRO+, the simulator must always be selected first. The individual setting options are discussed in the following sections.

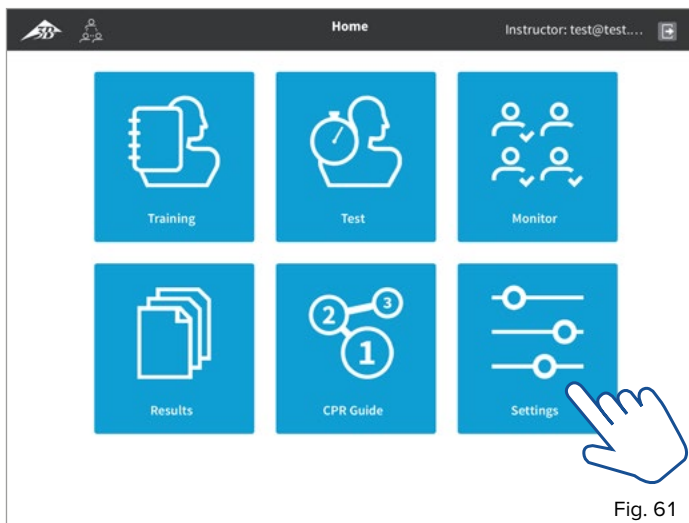

Fig. 61

- Start in the home screen (using the "back" and "home" buttons will always return you to the home screen). Select the "Settings" segment in the home screen by tapping the button.

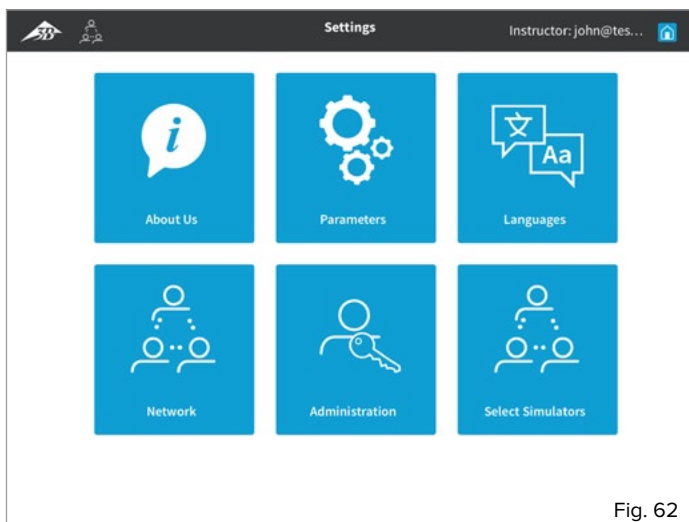

Fig. 62

- Select the appropriate segment according to the desired changes (please refer to the following sections for explanation).
- Use the "home" button to return to the home screen.

5.6.1 About us



Note:

The "About us" area contains general information about 3B Scientific and the software and related guidelines. This is not important for carrying out training and test activities.

5.6.2 Parameters



Note:

To adjust the requirements of the individual performance level of the trainee or due to special training requirements, all thresholds to the relevant feedback parameters can be set individually.



Tip:

We recommend that all training and test activities be conducted in accordance with current international guidelines. The thresholds will be updated in the software when the guidelines are reissued and can be easily and safely set up using the corresponding preset buttons.

The parameters are set for each CPRLilly PRO+, which means that the desired simulator must be selected from the list of available devices to make this change.

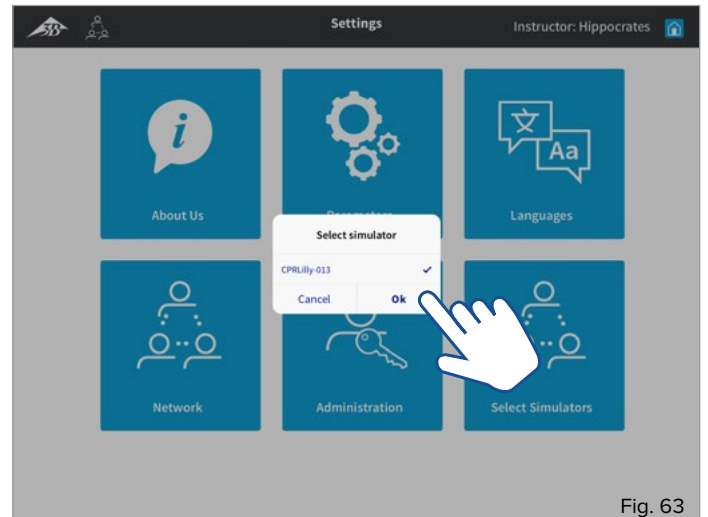

Fig. 63

- Select the "Parameters" segment in the Settings screen by tapping the button. A dialog box appears with a list of available devices.
- Select the desired CPRLilly PRO+ by tapping.
- Confirm the selection with "OK." "Cancel" will take you back to the Settings screen.

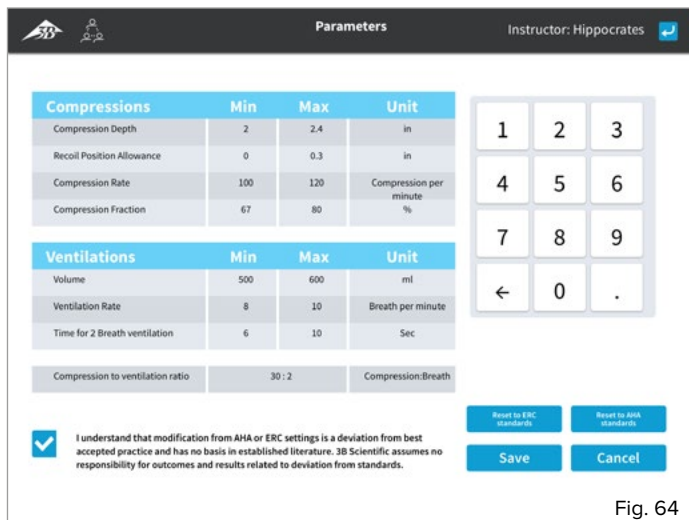



Fig. 64

- Select the desired Threshold (Min, Max) or compression-to-ventilation rate box by tapping and enter the changes using the input field (on the right).
- After you have adjusted all values accordingly and have checked the box for the liability disclaimer, confirm the selection with "Save".
- All changes are discarded by selecting "Cancel." If you select "Reset to ERC standards" and "Reset to AHA standards," the default settings are restored according to the guidelines.
- The "Back"  button takes you back to the Settings screen.
- Use the "home"  button to return to the home screen.

5.6.3 Languages

As a trainer, it is possible to set the operating language and the unit standard.

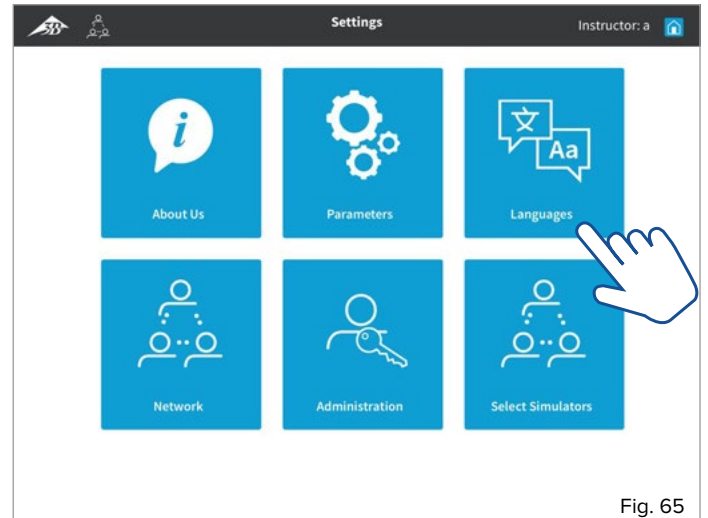



Fig. 65

- Select the "Languages" segment in the home screen by tapping the button.



Fig. 66

- In the left pane, select your desired language by tapping the button.
- In the right pane, you can choose between the metric and imperial units system. Select the desired unit system by tapping.
- The "Back"  button takes you back to the Settings screen.
- Use the "home"  button to return to the home screen.

5.6.4 Network



Note:

For the simultaneous operation of several CPRLilly PRO+ units, additional hardware and some initial installation steps may be necessary. The detailed description can therefore be found separately under "6. Network operation".

CPRLilly PRO+

5.6.5 Administration



Note:

In the event of a necessary update of the technical unit of the CPRLilly PRO+, an update of the operating software can be carried out by uploading an appropriate update file.

An update of the operating software is only necessary if a malfunction occurs or in exceptional circumstances. Customer Service deals with such cases. Contact them in the event of a malfunction.

- The update file for the operating software is provided by Customer Service (in the form of a download link).
- Download the update file and save it on the terminal.

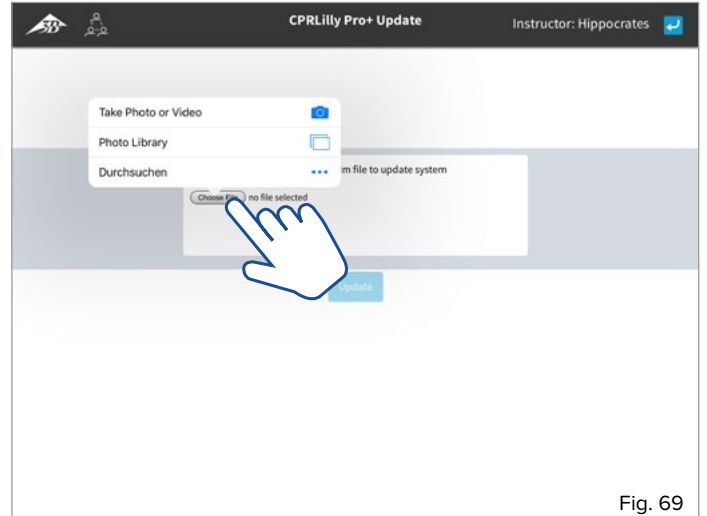



Fig. 69

- Select the previously saved update file with "Choose file" on the terminal.
- Start the installation of the update operating software by tapping the "Update" button.
- The "Back"  button takes you back to the Settings screen

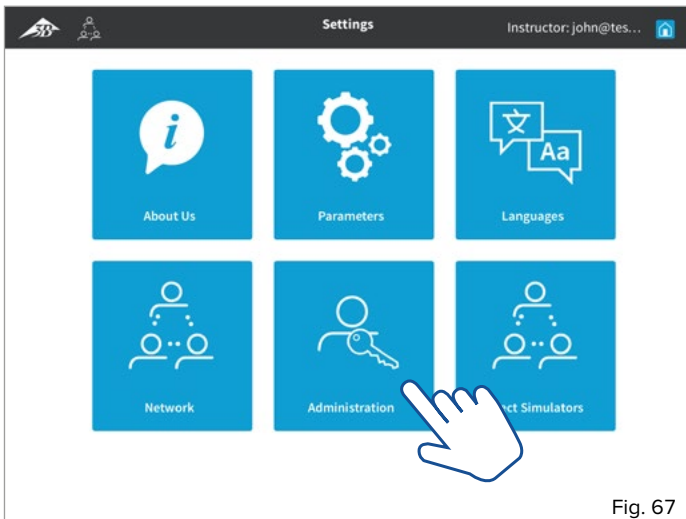

Fig. 67

- Select the **"Administration"** segment in the Settings screen by tapping the button.

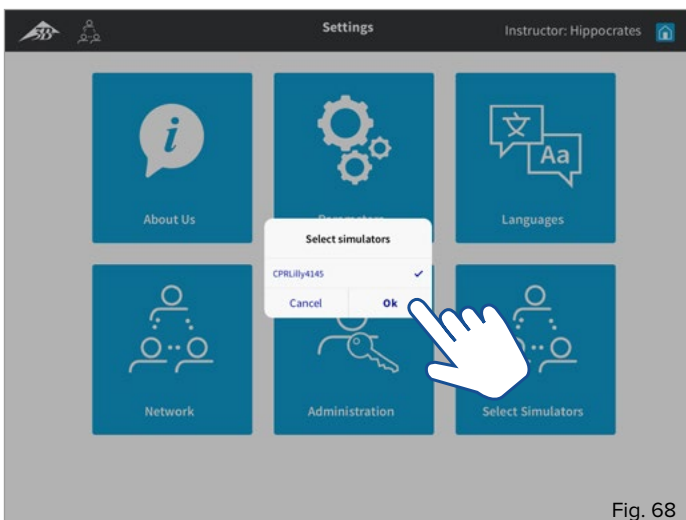

Fig. 68

- In the dialog box, select the CPRLilly PRO+ to be updated. Confirm the selection with "OK".

CPRLilly PRO+

5.6.6 Select Simulators



Note:

The "Select Simulators" application can add more CPRLilly PRO+ units to an existing, active network.



Tip:

Adding more CPRLilly PRO+ units is only possible in network mode. To run a training session in Network mode and to log a simulator into a network for the first time, follow the steps described in the section "6. Network operation."

Additional CPRLilly PRO+ units already recognized by the network can be added by simply selecting them while the system is running.

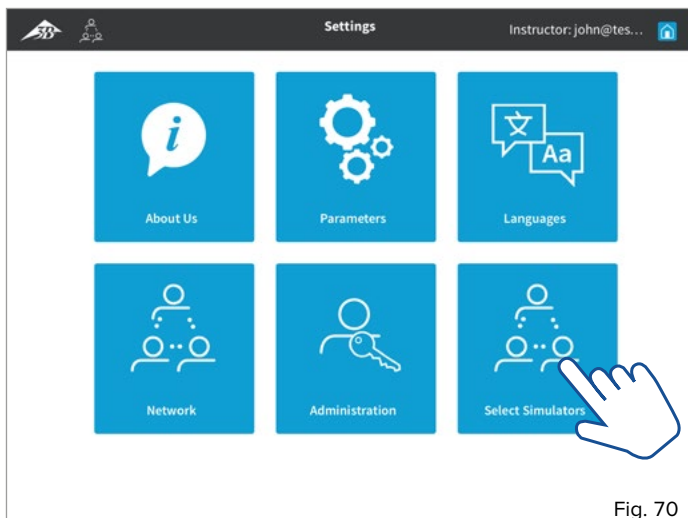

Fig. 70

- Select the **"Select Simulators"** segment in the Settings screen by tapping the button. A dialog box appears with a list of available devices.

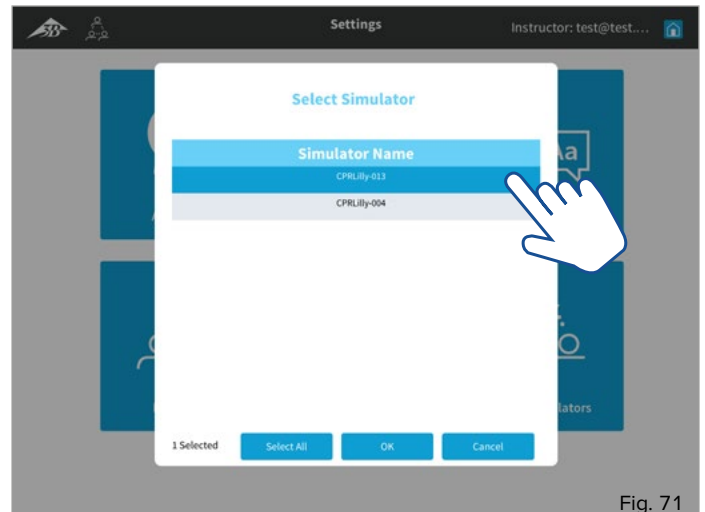

Fig. 71

- Select the desired CPRLilly PRO+ by tapping (multiple selection possible).
- For multiple selection, use the "Select all" button; to undo the selection, use the "Unselect all" button.
- Confirm the selection with "OK" or return to the Settings screen with "Cancel".

CPRLilly PRO+

6. Network operation



Tip:

Network operation requires some installation steps. Select this option only if you want to coordinate more than one CPRLilly PRO+ at a time.



Note:

The use of existing networks is expressly not recommended! To ensure smooth network operation, we recommend setting up a separate network (see the section "6.1 Router-based network") using the "Multi-manikin" router from our product range (article no. 1022268, see [Order list](#)). Under certain conditions, limited network operation is possible without a router (see the section "6.2 Restricted Network Operation").

6.1 Router-based network operations



Tip:

Make sure that the router with the established training network is always switched on a few minutes before the individual CPRLilly PRO+. This will ensure that the devices connect safely and quickly. However, if the network is not available, CPRLilly PRO+ automatically switches to "Hotspot Mode" and is only available for a one-to-one connection. To reintegrate the CPRLilly PRO+ into the network, follow the steps described below.



Note:

Individual CPRLilly PRO+ units in the network can only be accessed via the network (router). During the login process, either all CPRLilly PRO+ units available for connection will be displayed, or the user (trainee) will automatically be connected to the CPRLilly PRO+ on which the corresponding account is present. The trainer (Instructor) can select all CPRLilly PRO+ units together at the beginning or add them separately later (see "5.6.6 Select Simulators")

In addition to the individual connections between terminals and a simulator (Hotspot Mode), up to 10 CPRLilly PRO+ units and a total of 11 terminals can be controlled and monitored in parallel in Network mode. This requires an additional router, which you can obtain from 3B Scientific (article number: 1022268, see [Order list](#)). The setup (configuration) of the router is done according to the manufacturer's instructions (Attention: Use the 2.4 GHz setting only). The individual CPRLilly PRO+ unit can only be integrated and coordinated via the "Instructor" access. Individual CPRLilly PRO+ units must be individually selected and integrated into the network.

- First establish a direct network connection with the desired CPRLilly PRO+.
- Start the software application and log in as "Instructor" (for instructions, see "5. Logging in as a trainer").

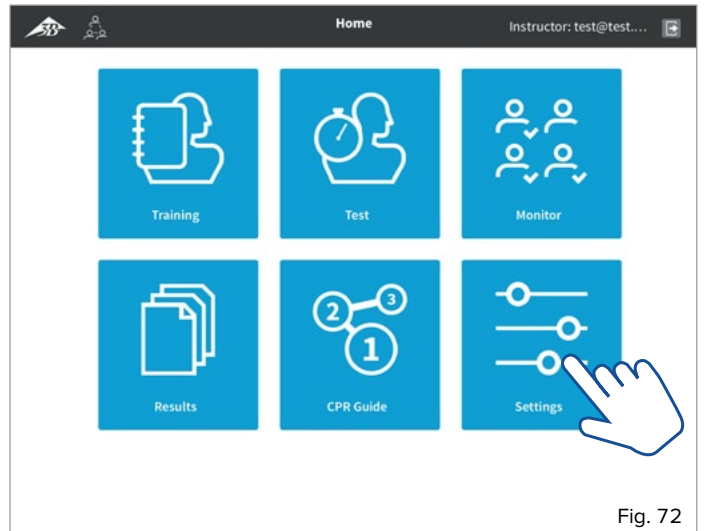

Fig. 72

- In the Home screen, select the button in the "Settings" segment and select the desired CPRLilly PRO+ from the list of available devices.

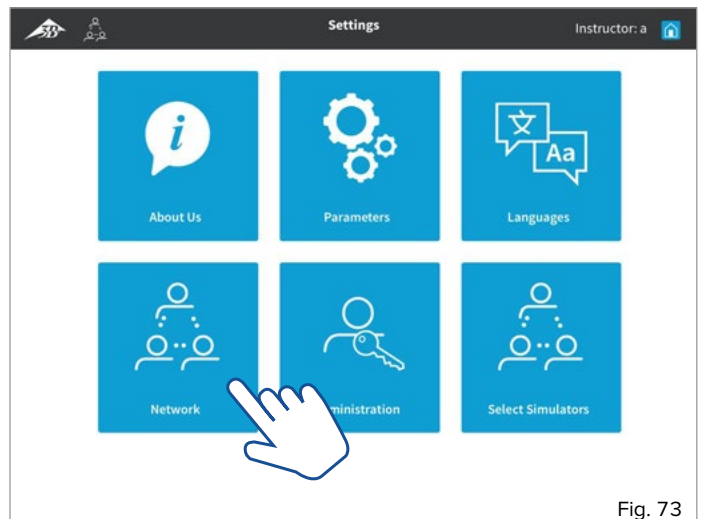

Fig. 73

- In the Settings screen, select the button for the "Network" segment.

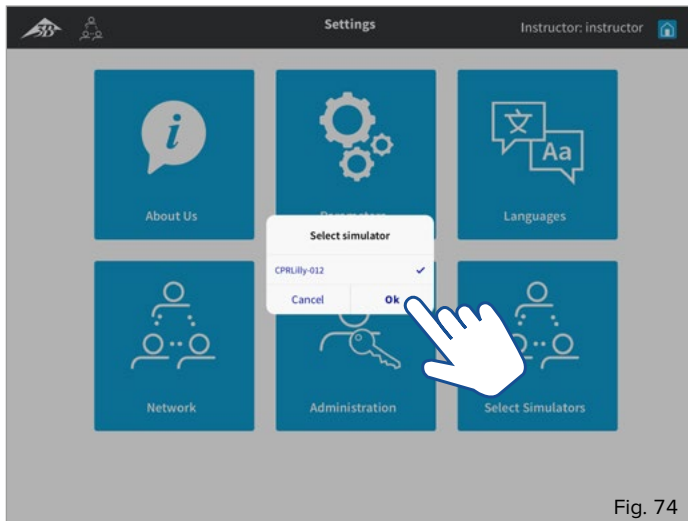

Fig. 74

- Select the CPRLilly PRO+ that you wish to integrate into the network by tapping and confirming with "OK". Use "Cancel" to go back to the Settings screen.

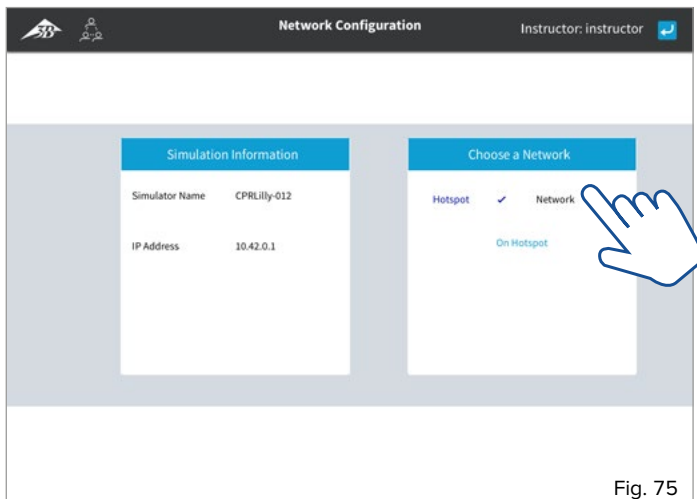

Fig. 75

- You now have access to the "Network Configuration" area. Tap "Network" in the "Chose a Network" section on the right.

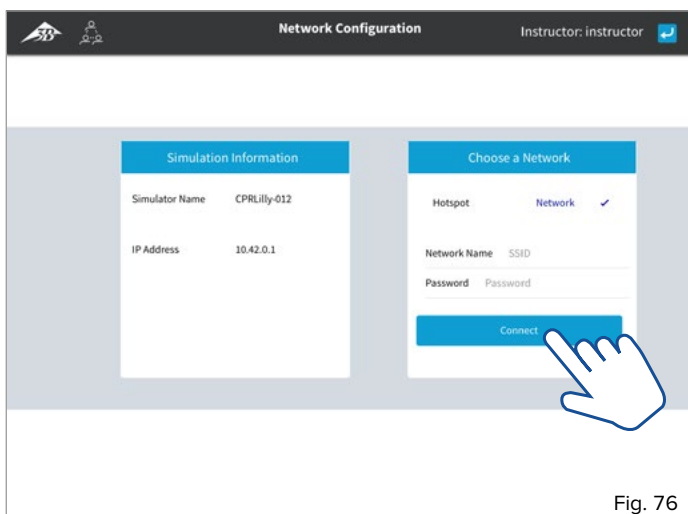

Fig. 76

- Enter the name and password of the network (individual router settings, case-sensitive) and select the "Connect" button.

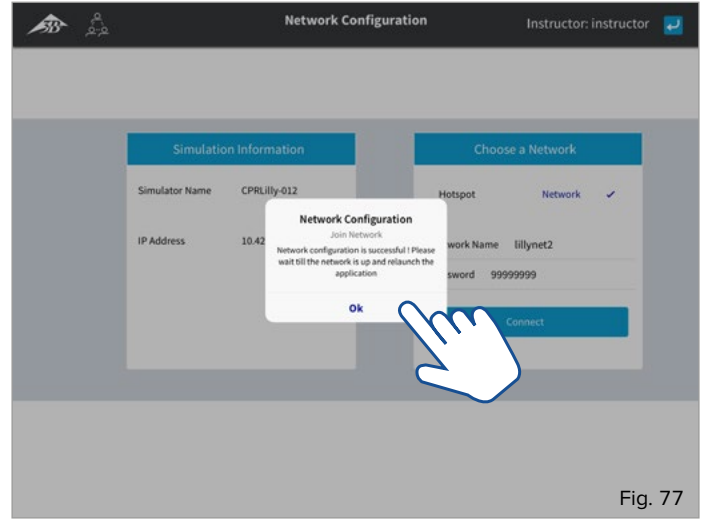

Fig. 77

- Confirm the dialog box indicating that the network has been correctly configured by pressing "OK". If the following notification appears: "Network configuration failed: Please check!", likewise confirm the dialog box with "OK". Use the "Back" button to go back to the Settings screen. Here, select "Network" again and re-enter "Network Name" and "Password".
- Completely close the software application by swiping it away!
- Decide whether you want to integrate more CPRLilly PRO+ units into the network.
- **No:** Select the network connection of the configured router network at your terminal. The simulator network (individual CPRLilly PRO+ units) disappears automatically after a few seconds from the network selection.
- Start the software application and log in as a trainee or as an "Instructor". All functions as described in the individual sections are now available to you.
- **Yes:** Select the network connection of the other CPRLilly PRO+ units that you want to integrate into the network on your terminal.
- Now proceed again as described above. You can integrate up to 9 more CPRLilly PRO+ units into the network.
- After complete integration of all desired CPRLilly PRO+ units, connect to the router network to access all CPRLilly PRO+ units.
- To log on, please follow the instructions as described in "4. Logging in as a trainee with a user account" or "5. Logging in as a trainer."

6.1.1 Network operation when using desktop computers



Note:

If you would like to use the browser variant of the software to connect to a CPRLilly PRO+, which is located in a router-based network, you need a router-specific IP address. This can be read from the router used.

In the router-based network, the router creates a new IP address for each CPRLilly PRO+. To detect one of these specific IP addresses of the router you are using, please follow the instructions below. Depending on the number of CPRLilly PRO+ units in the network, several specific IP addresses are generated. For further use, any IP address can be used.

Attention: The instructions refer only to the recommended "Multi-man-ikin" router from our line of products (Article number: 1022268, see [Order list](#)).

- Create a WLAN connection to the previously established network with your desktop computer.
- Open the browser and enter the IP address "192.168.0.1" in the address field of the browser and confirm with "Enter".
- Log in with your access data in the configuration menu of the router (access data of the factory setting can be found on the bottom of the device).
- Select the menu item "DHCP" and then the sub-item "DHCP Clients List". Here you will find an overview of all devices logged in to the network.
- Make a note of the "Assigned IP" of one of the listed CPRLilly PRO+ wi-fi IDs.
- Close the configuration menu by selecting the menu item "Logout".
- Enter the IP address obtained in the address field of the browser and confirm with "Enter" to gain access to the network.
- To log in, please follow the instructions given in "[4. Logging in as a trainee with a user account](#)" or "[5. Logging in as a trainer](#)."

CPRLilly PRO+

6.2 Restricted network operation



Tip:

The limitations of network operation without a router should first be balanced with training objectives. Otherwise, always opt for router-based network operation as this ensures the full availability of up to 10 CPRLilly PRO+ units.



Note:

Access to individual CPRLilly PRO+ units in the restricted network is only possible by connecting to the CPRLilly PRO+ which was designated as a router replacement. During the login process, either all CPRLilly PRO+ units available for connection are displayed, or the user (trainee) is automatically connected to the CPRLilly PRO+ which already has the corresponding account. The trainer (Instructor) can select all CPRLilly PRO+ units together at the beginning or add them separately later (see "5.6.6 Select Simulators")

In addition to the individual connections between mobile terminals and a simulator (Hotspot Mode) and the network connection supported by the router, up to 4 CPRLilly PRO+ units and a total of 5 terminals can be controlled and monitored in parallel in a network mode without an additional router. In this network, a CPRLilly PRO+ is determined which acts as a router (This CPRLilly PRO+ is still available as a fully functional training device). After a CPRLilly PRO+ has been designated as a "router replacement", the other individual CPRLilly PRO+ units can be integrated and coordinated in the same way as for a router-based network.

- Choose a CPRLilly PRO+ as a router replacement and identify it by the individual name (CPRLillyxxxx – you will find the name below the battery compartment cover).
- Now establish a direct network connection with a CPRLilly PRO+ (not the CPRLilly PRO+ which serves as a router replacement) that you want to integrate into the network.
- Start the software application and log in as "Instructor" (for instructions, see "5. Logging in as a trainer").

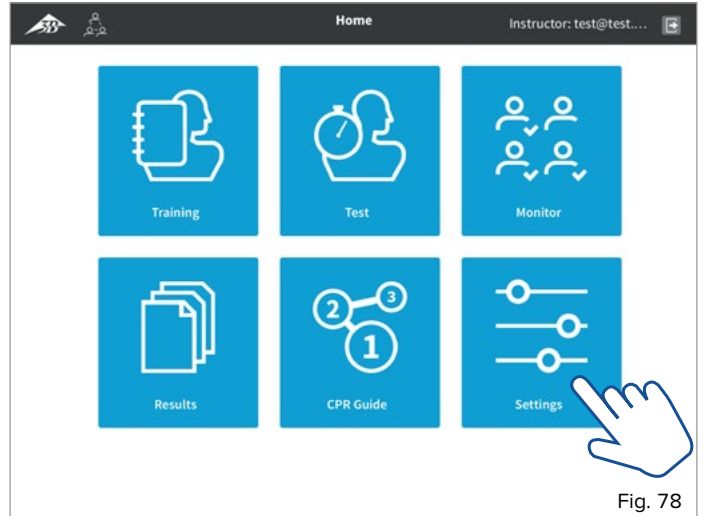

Fig. 78

- In the Home screen, select the button in the "Settings" segment and select the desired CPRLilly PRO+ from the list of available devices.

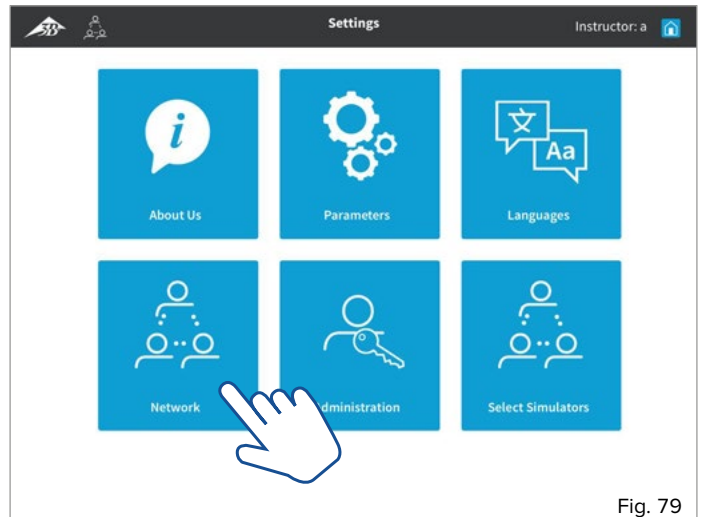

Fig. 79

- In the Settings screen, select the button for the "Network" segment.

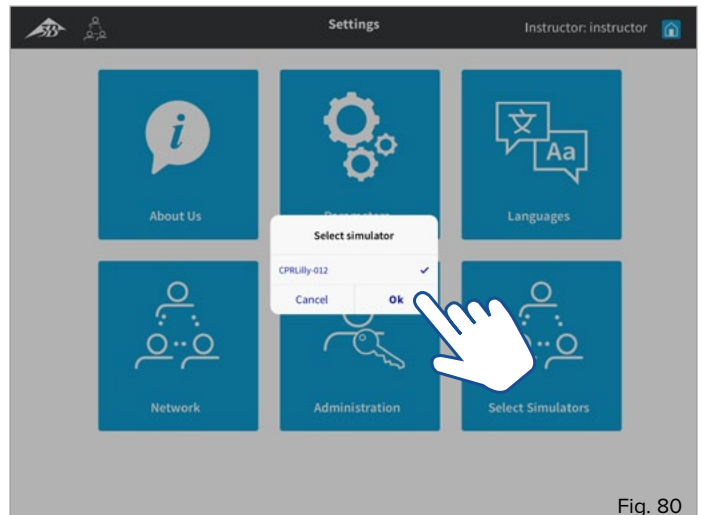

Fig. 80

- Select the CPRLilly PRO+ that you wish to integrate into the network by tapping and confirming with "OK". Use "Cancel" to go back to the Settings screen.

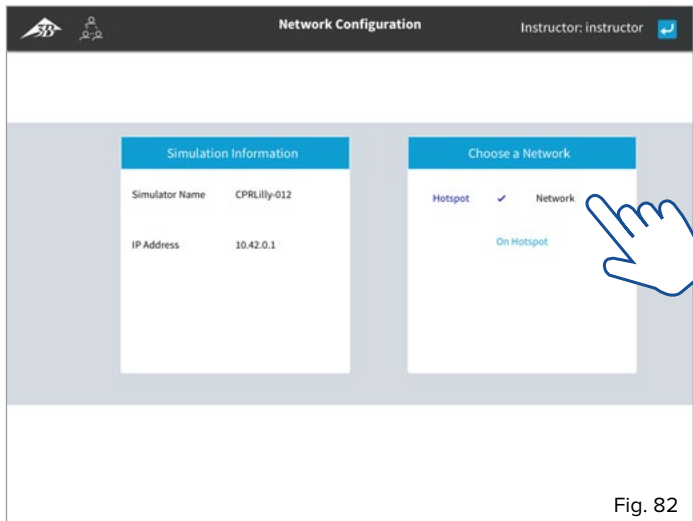

Fig. 82

- **Yes:** Select the network connection of the other CPRLilly PRO+ units that you want to integrate into the network on your terminal.
- Now proceed again as described above. You can integrate up to 2 more CPRLilly PRO+ units into the network.
- After completing integration of all desired CPRLilly PRO+ units, connect to the CPRLilly PRO+ which has been designated as a router replacement to access all CPRLilly PRO+ units.
- To log on, please follow the instructions as described in "4. Logging in as a trainee with a user account" or "5. Logging in as a trainer".

- You now have access to the "Network Configuration" area. Tap **"Network"** in the "Choose a Network" section on the right.

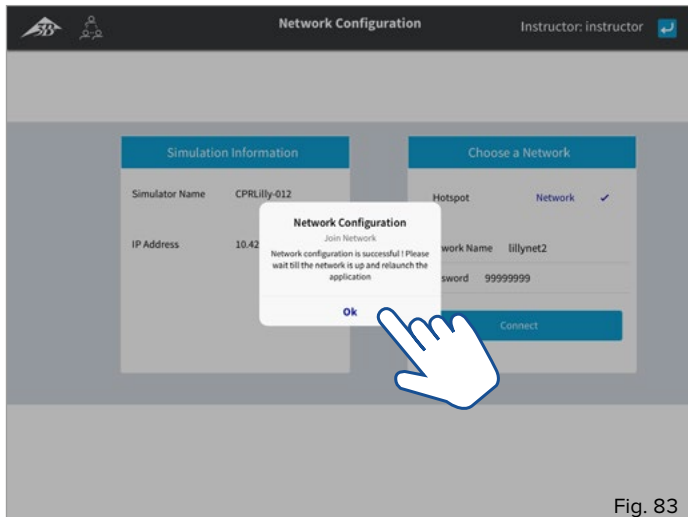

Fig. 83

- Enter the name and password of the CPRLilly PRO+ as "Router Replacement" (individual name **"CPRLillyxxx"**, password: **"simadmin"**; case-sensitive) and select the "Connect" button.
- Confirm the dialog box indicating that the network has been correctly configured by pressing "OK". If the following notification appears: "Network configuration failed: Please check!", likewise confirm the dialog box with "OK". Use the "Back" button to go back to the Settings screen. Here, select "Network" again and re-enter "Network Name" and "Password".
- Completely close the software application by swiping it away!
- Decide whether you want to integrate more CPRLilly PRO+ units into the network.
- **No:** Select the network connection of the configured router network at your terminal. The simulator network (individual CPRLilly PRO+ units) disappears automatically after a few seconds from the network selection.
- Start the software application and log in as a trainee or as an "Instructor". All functions as described in the individual sections are now available to you.

CPRLilly PRO+

7. Use of an AED device



Tip:

The CPRLilly PRO+ has an AED electrode system to detect whether the individual (electrode) pads have been correctly fitted and how long it took to position them properly. This information is automatically logged.



Note:

Basically both AED training devices and "hot" AED devices can be used. Please note, however, that **no currents** are applied regardless of the device used as this can cause massive damage to the CPRLilly PRO+. The focus of the AED training is on the correct positioning of the AED electrodes (pads). Students must train separately for the correct use of a "hot" AED. If a "hot" AED is used, the responsibility for correct handling lies with the trainer. 3B Scientific accepts no liability for any damage caused by improper use of a "hot" AED!

The CPRLilly PRO+ is equipped with sensors that detect the correct placement of the electrode pads on the AED. When using an AED training device, prepare the electrode pads (dummies) according to the following instructions. You will receive 12 AED pad adapters included with your CPRLilly PRO+. Additional AED pad adapters can be ordered (see [Order List](#) at the end of this document). When using a "hot" AED, no preparation is necessary.



Fig. 84

- Stick one AED pad adapter on top of each electrode (side away from the adhesive surface or body).



Fig. 85

- Use the AED in training as intended (**Attention:** Only the attachment of the electrode pads. Do NOT apply currents or shocks!)
- The correct placement of the electrode pads is displayed in all training and test screens and in the respective logs and then evaluated.

> GENERAL SAFETY INSTRUCTIONS

- Packaging material of the CPRLilly PRO+ is not a toy for children – danger of suffocation!
- Do not use sharp objects (e.g. knives) with the simulator.
- CPRLilly PRO+ must not be used near an open flame.
- Do not operate the CPRLilly PRO+ outside in heavy rain
- Do not immerse the CPRLilly PRO+ in water.
- Do not remove the bolts at the 'head joint' (danger of injury).
- "Noises" may occur when operating the CPRLilly PRO+. This is not a malfunction!
- **Important!** Do not press the abdominal area. There is a danger of damaging the electronics.
- The CPRLilly PRO+ should only be ventilated if a throat bag has been used.
- Replacing bags in the rain is not recommended (water may enter the inner ventilation circuit of the CPRLilly PRO+).

> FAQ

- **Can I use my own song for the simulation?**
No.

- **Where do I select the language?**
In the Settings window under the heading Language.

- **The compression cycle has ended, although 30 compressions have not yet been performed.**
If you wait for more than 10 seconds after a compression, a new cycle is automatically started in the software.

- **What do the flashing patterns of the LED illuminated ring mean?**
 - Lights up green: CPRLilly PRO+ is switched on and ready for operation
 - Does not light up: CPRLilly PRO+ is not switched on
 - Flashes green constantly: CPRLilly PRO+ is shutting down
 - Flashes green once: CPRLilly PRO+ is charging, the battery is empty
 - Flashes green twice: CPRLilly PRO+ is charging, the battery is half charged
 - Flashes green three times: CPRLilly PRO+ is charging, the battery is completely charged.

> CLEANING AND MAINTENANCE

The surfaces of the simulator can be cleaned with a damp cloth. All parts that come into contact with breathing air, such as facial skin, mouthpiece and air bag holder, can be disinfected with disinfectant or cleaned in a dishwasher (the disposable airways (throat bag) ensure an especially hygienic use). Please do not use harsh chemicals for cleaning as this may damage the model materials. The training jacket can be washed by hand or in the washing machine with commercial detergents in warm water at maximum of 40 °C. Please make sure that all parts are completely dry before stowing.



Note:

Do not use solvent-based cleaning agents as this could damage the surface. Labeling and marking of the surface should be avoided as it may cause permanent discoloration.

> TECHNICAL DATA

Dimensions: Simulator (H×W×D) 26 × 39 × 78 cm
Weight: 9.7 kg
Operating temperature: 0 °C up to +30 °C
Storage temperature: -10 °C up to +40 °C
The related plastics comply with the Toy Directive
DIN EN 71-3/9

> CONNECTED LOAD

Supply voltage: 15 V
Extra-low safety voltage (Device Class III)

> ORDER LIST

Art. No.	Replacement part
1017737	Upper face mask, light
1017764	Upper face mask, dark
1022527	Lower face mask with teeth (5x), light
1022528	Lower face mask with teeth (5x), dark
1017739	Throat bags (pack of 50)
1017743	Throat bags (pack of 100)
1022526	Carrying case with mat
1017748	Bag clip
1013678	Bag valve mask
1022268	Multi-manikin router

> COMPANY INFORMATION



3B Scientific

A worldwide group of companies

3B Scientific GmbH

Ludwig-Erhard-Straße 20 • 20459 Hamburg • Germany
Phone: + 49 (0)40-73966-0 • Fax: + 49 (0)40-73966-100
3bscientific.com • info@3bscientific.com