

Set of 4 Conductors for Biot-Savart Experiment 1018478

Instruction manual

12/15 TLJS

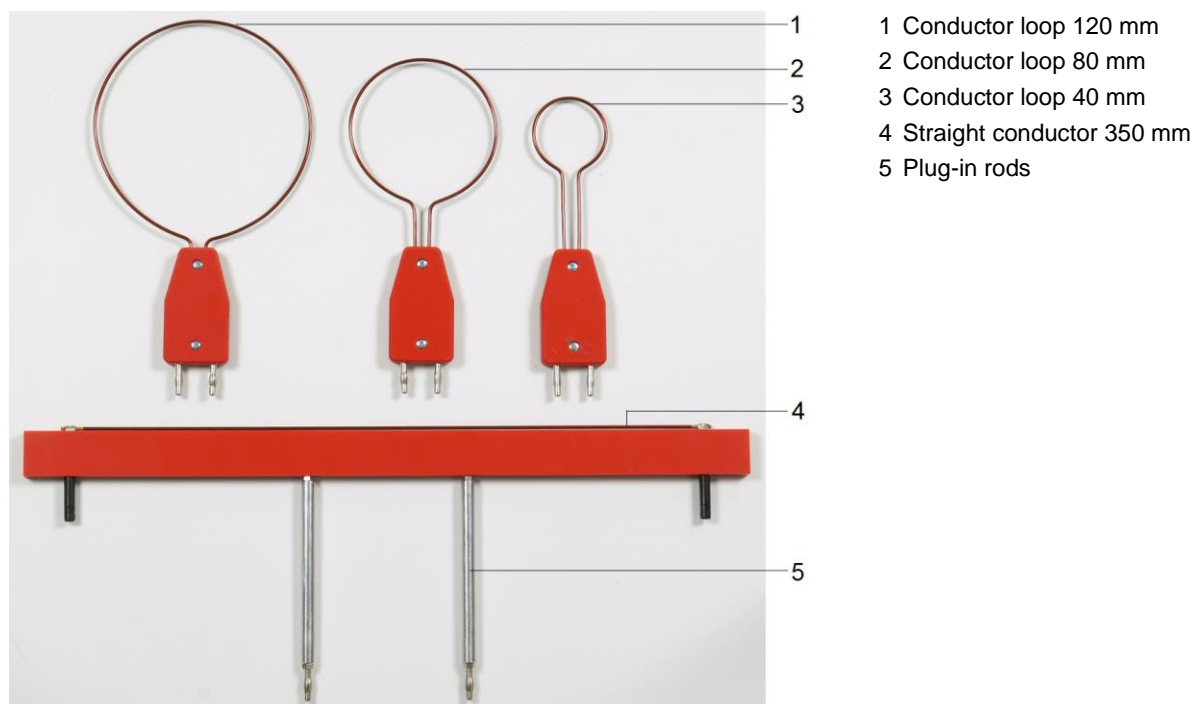

- 1 Conductor loop 120 mm
- 2 Conductor loop 80 mm
- 3 Conductor loop 40 mm
- 4 Straight conductor 350 mm
- 5 Plug-in rods

1. Safety instructions

The conductors in the set of 4 conductors for the Biot-Savart experiment are exclusively for use as stipulated. A voltage of less than 2 V is sufficient to produce currents of up to 20 A.

- Do not connect the conductors to a voltage which would make them dangerous to touch.

The conductors are made of soft copper.

- Do not subject the conductors to excessive force.
- To hold the conductors and provide electrical contact, use the holding rod for plug-in components (1018449).

2. Description

The set of 4 conductors for the Biot-Savart experiment are intended to demonstrate and measure, by means of magnetic field sensors, the magnetic fields associated with conductors which are formed into loops or stretched out straight. The conductors are of such height that their central axes are all at the same level.

3. Equipment

- 1 Conductor loop, 120 mm
- 1 Conductor loop, 80 mm
- 1 Conductor loop, 40 mm
- 1 Straight conductor, 350 mm
- 2 Plug-in rods

4. Technical data

Height of central axis:	130 mm
Height including holding rod:	264 mm
Length of straight conductor:	350 mm
Diameter of conductor loops:	40, 80, 120 mm
Total weight:	300 g approx.
Maximum current:	20 A

5. Operation

5.1 Conductor loops

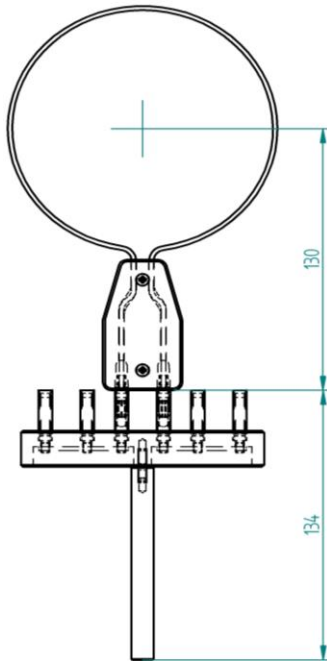

Fig.1 Dimensions of conductor loops when set up on holding rod for plug-in components (1018449)

- Plug the conductor loops into the centre sockets of the plug-in component holder.
- Connect the outside sockets of the holder for plug-in elements to the power supply.

5.2 Straight conductor

- The conductor which is stretched out straight should be plugged in to the outside sockets of the holder for plug-in components by means of the plug-in rods.
- Connect the sockets on the supporting rail for the outstretched conductor to the power supply.

6. Experiments

Additionally required equipment:

1 Teslometer E	1008537
1 Flexible magnetic field sensor	1012892
or	
1 Axial/tangential magnetic field sensor	1001040
1 BS holder for magnetic field sensor	1019212
1 DC power supply, 20 A @230 V	1012857
or	
1 DC power supply, 20 A @115 V	1012858
1 Holding rod for plug-in components	1018449
1 Optical bench U	1003040
2 Optical riders U, 75 mm	1003041
Experiment leads with cross section 2.5 mm ²	

- Keep the distance between the conductor loops and the power supply as great as possible.
- Twist the experiment leads together by several turns and run them down vertically.

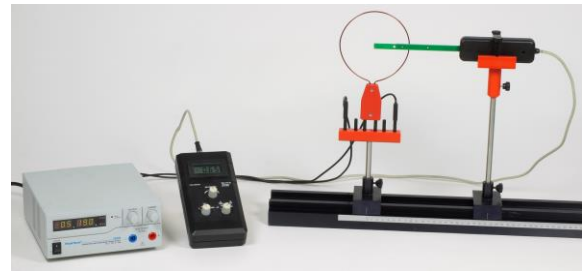

Fig. 2 Experiment set-up

6.1 Magnetic flux density B at the centre of conductor loop as a function of current I

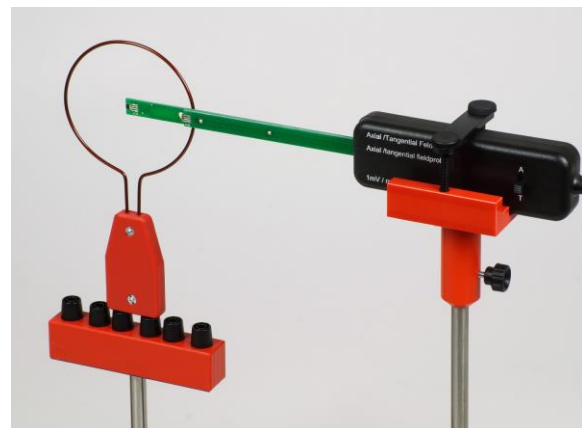

Fig. 3 Set-up with axial/tangential magnetic field sensor

6.2 Magnetic flux density B as a function of distance from centre of conductor loop

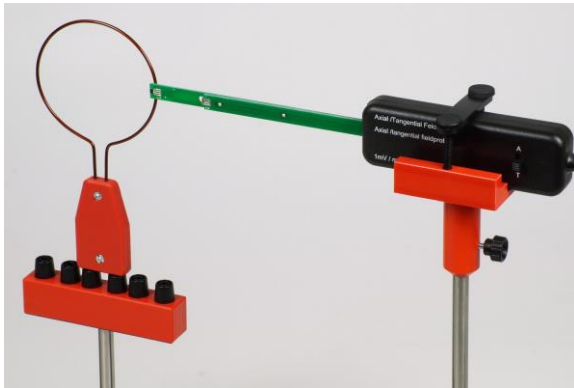

Fig. 4 Set-up with axial/tangential magnetic field sensor

6.3 Magnetic flux density B at centre of outstretched conductor as a function of current I

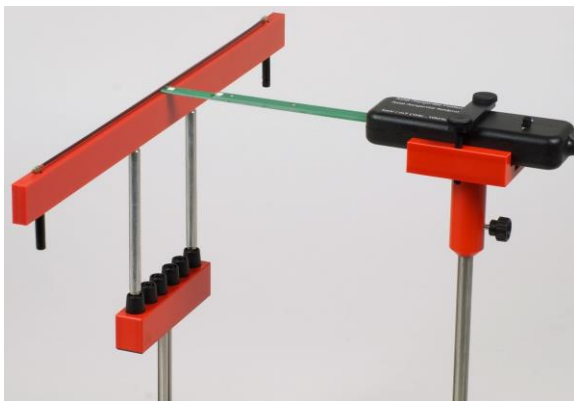

Fig.5 Set-up with axial/tangential magnetic field sensor

6.4 Magnetic flux density B as a function of distance r from outstretched conductor

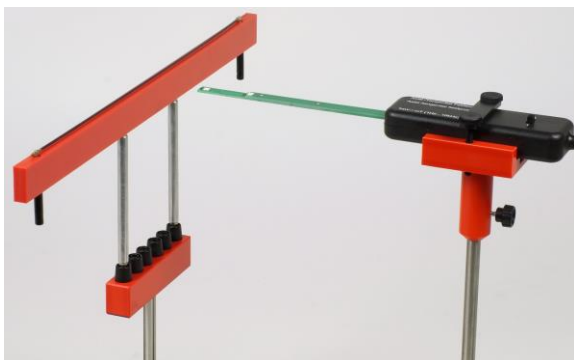

Fig. 6 Set-up with axial/tangential magnetic field sensor

7. Storage, cleaning and disposal

- Keep the equipment in a clean, dry and dust-free place.
- Before cleaning the equipment, disconnect it from its power supply.
- Do not use any aggressive cleaning agents or solvents to clean the equipment.
- Use a soft damp cloth for cleaning.

Should you need to dispose of the equipment itself, never throw it away in normal domestic waste. If being used in private households it can be disposed of by the local public waste disposal authority.



- Comply with applicable regulations for the disposal of electrical equipment.

