

THE BIOTECHNOLOGY  
EDUCATION COMPANY®

REVISED  
&  
UPDATED

Edvo-Kit #  
**332**

Edvo-Kit #332

## The Mother of All Experiments: Exploring Human Origin by PCR Amplification of Mitochondrial DNA

### Experiment Objective:

In this experiment, students will isolate their mitochondrial DNA and use the Polymerase Chain Reaction (PCR) to amplify two separate regions of the mitochondrial genome. Results are analyzed using agarose gel electrophoresis.

See page 3 for storage instructions.

LyphoPrimer™

LyphoControl™

### IMPORTANT NOTE:

The PCR cycling conditions and electrophoresis buffer have changed. Please review the literature before performing the experiment.

# Table of Contents

	Page
Experiment Components	3
Experiment Requirements	4
Background Information	5
Experiment Procedures	
Experiment Overview	10
Module I-A: Isolation of DNA from Human Cheek Cells	11
Module I-B: Isolation of DNA from Human Hair	12
Module II: Amplification of the Mitochondrial Regions	13
Module III: Separation of PCR Products by Electrophoresis	14
Module IV: Staining Agarose Gels with FlashBlue™ Stain (OPTIONAL)	17
Study Questions	18
Instructor's Guidelines	19
Pre-Lab Preparations	20
Experiment Results and Analysis	24
Answers to Study Questions	25
Appendices	26
A EDVOTEK® Troubleshooting Guide	27
B Bulk Preparation of Electrophoresis Buffer and Agarose Gels	29

Safety Data Sheets can be found on our website: [www.edvotek.com/safety-data-sheets](http://www.edvotek.com/safety-data-sheets)

## EDVO-TECH Service

**1.800.EDVOTEK**

Mon. - Fri. 8am-5:30pm EST



### Please Have the Following Info:

- Product Number & Description
- Lot Number on Box
- Order/Purchase Order #
- Approx. Purchase Date

Fax: 202.370.1501 • [info@edvotek.com](mailto:info@edvotek.com) • [www.edvotek.com](http://www.edvotek.com)

[www.edvotek.com](http://www.edvotek.com)

- Online Catalog
- Order Products
- Experiment Protocols
- Tech Support
- Resources!



1.800.EDVOTEK • Fax 202.370.1501 • [info@edvotek.com](mailto:info@edvotek.com) • [www.edvotek.com](http://www.edvotek.com)

Duplication of any part of this document is permitted for non-profit educational purposes only. Copyright © 1989-2019 EDVOTEK, Inc., all rights reserved. 332.190422

## Experiment Components

Component	Storage	Check (✓)
<ul style="list-style-type: none"> <li>PCR EdvoBeads™ PLUS <i>(Each PCR EdvoBead™ PLUS contains: dNTP Mixture, Taq DNA Polymerase Buffer, Taq DNA Polymerase, and MgCl<sub>2</sub>)</i></li> </ul>	Room Temp.	<input type="checkbox"/>
A Universal DNA Buffer	-20° C Freezer	<input type="checkbox"/>
B TE Buffer	-20° C Freezer	<input type="checkbox"/>
C Mitochondrial LyphoPrimer™ Mix	-20° C Freezer	<input type="checkbox"/>
D LyphoControl™ <i>(Complete PCR Control)</i>	-20° C Freezer	<input type="checkbox"/>
E EdvoQuick™ DNA ladder	-20° C Freezer	<input type="checkbox"/>
<ul style="list-style-type: none"> <li>Proteinase K</li> </ul>	-20° C Freezer	<input type="checkbox"/>

**NOTE:** Components C and D are now supplied in our LyphoPrimer™ and LyphoControl™ form and require reconstitution prior to setting up PCR reactions.

This experiment is designed for 25 human DNA typing reactions.

**NOTE:**

The PCR cycling conditions and electrophoresis buffer have changed. Please review the literature before performing the experiment.

### REAGENTS & SUPPLIES

Store all components below at room temperature.

Component	Check (✓)
<ul style="list-style-type: none"> <li>UltraSpec-Agarose™</li> <li>TBE Electrophoresis Buffer Powder</li> <li>SYBR® Safe Stain</li> <li>FlashBlue™ Stain</li> <li>Snap-top Microcentrifuge Tubes</li> <li>Screw-top Microcentrifuge Tubes (1.5 mL - use for boiling)</li> <li>0.2 mL PCR tubes</li> <li>Disposable plastic cups</li> <li>Salt packets</li> <li>15 mL conical tube</li> </ul>	<input type="checkbox"/> <input type="checkbox"/> <input type="checkbox"/> <input type="checkbox"/> <input type="checkbox"/> <input type="checkbox"/> <input type="checkbox"/> <input type="checkbox"/> <input type="checkbox"/> <input type="checkbox"/>

All experiment components are intended for educational research only. They are not to be used for diagnostic or drug purposes, nor administered to or consumed by humans or animals.

EDVOTEK and The Biotechnology Education Company are registered trademarks of EDVOTEK, Inc. SYBR is a registered trademark of Thermo Fisher Scientific. EdvoBead, LyphoPrimer, LyphoControl, UltraSpec-Agarose, FlashBlue and EdvoQuick are trademarks of EDVOTEK, Inc.

1.800.EDVOTEK • Fax 202.370.1501 • [info@edvotek.com](mailto:info@edvotek.com) • [www.edvotek.com](http://www.edvotek.com)

Duplication of any part of this document is permitted for non-profit educational purposes only. Copyright © 1989-2019 EDVOTEK, Inc., all rights reserved. 332.190422



## Requirements

---

- Thermal cycler (EDVOTEK® Cat. #541 highly recommended)
- Horizontal gel electrophoresis apparatus
- D.C. power supply
- Balance
- Microcentrifuge
- Two Water baths for 55° C and 99° C Incubations (EDVOTEK® Cat. #539 highly recommended)
- UV Transilluminator or Blue light visualization (EDVOTEK® Cat. #557 or #558 highly recommended)
- White light visualization system (OPTIONAL - use if staining with FlashBlue™)
- UV safety goggles
- Automatic micropipettes (5-50 µL) with tips
- Microwave
- Pipet pump
- 250 mL flasks or beakers
- Hot gloves
- Safety goggles
- Disposable vinyl or latex laboratory gloves
- Ice buckets and ice
- Distilled or deionized water
- Drinking Water (if isolating DNA from cheek cells)
- Bleach solution



## Background Information

Mitochondria are tiny organelles found in almost every cell of both plants and animals. They are commonly known as a cell's "powerhouse" because they generate much of the energy needed for an organism to survive and grow. However, mitochondria are also living history records. Using biotechnology and mathematical models, geneticists can translate similarities and differences in the mitochondrial genomes of a population into hypotheses about where a great grandparent migrated from, how a species survived the last ice age, and when key evolutionary steps occurred. Such investigations can be carried out for all eukaryotic life from trees to fungi to birds. However, *Homo sapiens* seem to receive particular attention. By studying our own mitochondrial DNA (mtDNA) we can better understand how human societies and cultures developed, how we shaped the environments we moved into, and even why individuals are susceptible to certain diseases.

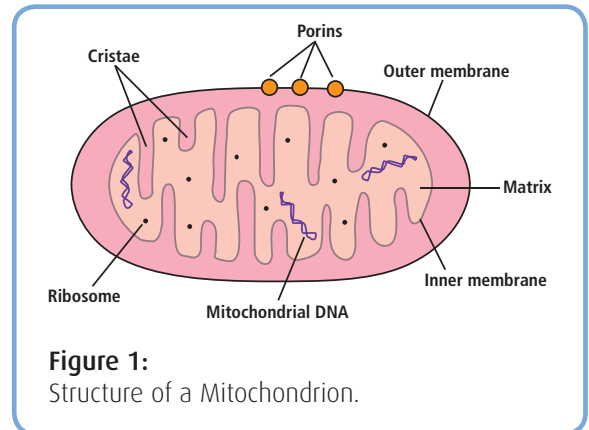

**Figure 1:**  
Structure of a Mitochondrion.

### Human Mitochondria and Mitochondrial DNA

While their size, structure, and density vary tremendously - mitochondria are present in (almost) all human cells. These organelles are generally oblong and always contain a double membrane (Figure 1). A double membrane helps to greatly increase the total surface area of each mitochondria and also enables the formation of an electron gradient. This gradient is essential to the primary job of mitochondria which is to convert the biochemical energy contained in sugars and fatty acids into the more usable currency of adenosine triphosphate (ATP) (Figure 2). In addition to this process known as respiration, mitochondria are also involved in cell cycle control and cell signaling.

During the past twenty years, a number of diseases have been linked to mitochondrial dysfunction. These disorders result when particular tissues need more ATP than their mitochondria are producing. Because muscle and nerve cells contain large numbers of mitochondria, these organ systems are most affected by mitochondrial dysfunction. For example, both Alzheimer's and Parkinson's disease are thought to involve mitochondrial abnormalities.

Mitochondria contain their own DNA that replicates and divides independent of the nuclear genome. This - along with the general size and shape of the mtDNA genome, the presence of bacteria-like genes, and the organelle's double membrane - has led scientists to propose that mitochondria originated through endosymbiosis. The endosymbiosis theory suggests that, at some point early in life's evolution, a single cell organism engulfed another bacteria and the two developed a mutually beneficial relationship that continues to this day in all eukaryotes.

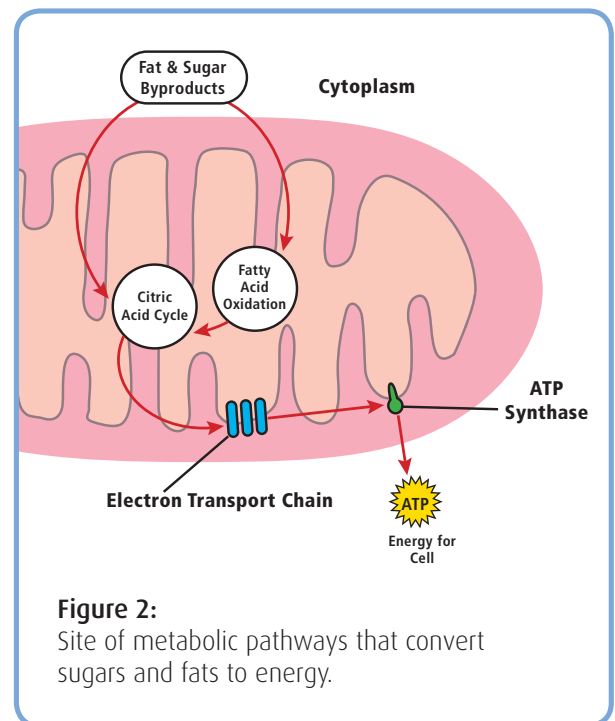

**Figure 2:**  
Site of metabolic pathways that convert sugars and fats to energy.

In humans, the mtDNA genome contains 16,569 bp of DNA that codes for 37 genes (Figure 3). These genes create proteins that make up part of the electron transport chain, the enzyme ATP synthase, as well as mitochondrial-specific RNA. In addition, there is also a highly variable region of the genome known as the D-loop. This variable region is responsible for mtDNA's high mutation rate, which is 5-10 times faster than nuclear DNA.

Another important feature of human mtDNA is that it is inherited only from a person's mother (but see News Box). Mitochondria (and mitochondrial DNA) are present in multiple copies in the cytoplasm. For instance, in humans, a female egg cell possesses over 10,000 mitochondria. In contrast, a sperm cell has very few mitochondria. Moreover, paternal mtDNA appears to be selectively destroyed following fertilization. Consequently, while a child will inherit nuclear DNA from both its mother and father he or she will inherit mitochondrial DNA exclusively from the mother.

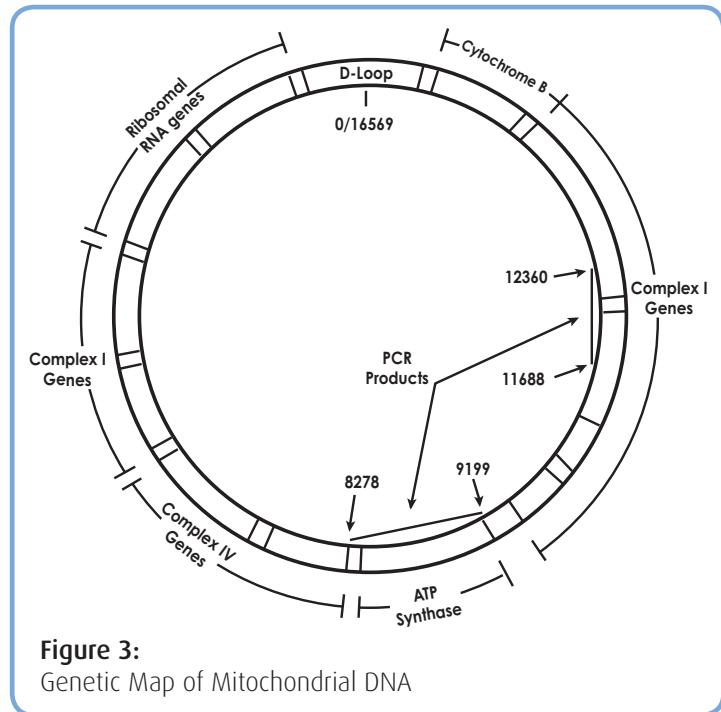

**Figure 3:**  
Genetic Map of Mitochondrial DNA

This maternal inheritance is key to allowing geneticists to trace ancestry back through generations and even back to a single shared ancestor that existed hundreds of thousands of years ago.

**Mitochondrial Eve**

The last common ancestor (LCA) is the most recent individual from which all organisms in a group are directly descended. Visually, if you imagine a bifurcating tree as representing the history of a group the LCA is the first node that all selected tips branch back to (Figure 4).

The LCA can be calculated for any set of individuals. The LCAs of you and your cousin are your grandparents. The LCA of all eukaryotes is likely the pair of bacteria who became a single cellular creature with mitochondria. The most recent common ancestor of all current life on Earth is nicknamed LUCA (Last Universal Common Ancestor) and is estimated to have lived 3.5 to 3.8 billion years ago.

Being able to identify a LCA and its genetic makeup helps scientists interpret the patterns of relatedness between individuals. Scientists can also use supplementary information - such as knowledge about mutation rates or the geographic distribution of a group's genetic diversity- to estimate when and where the LCA existed. Like any group of related individuals, humans have a LCA from which we are all descended. However, there

**IN THE NEWS:**

In 2019 scientists challenged the long held tenant of exclusively maternal mtDNA and found that in rare cases the father can pass on his mtDNA. Read Luo et al<sup>2</sup>. (2018) for details.

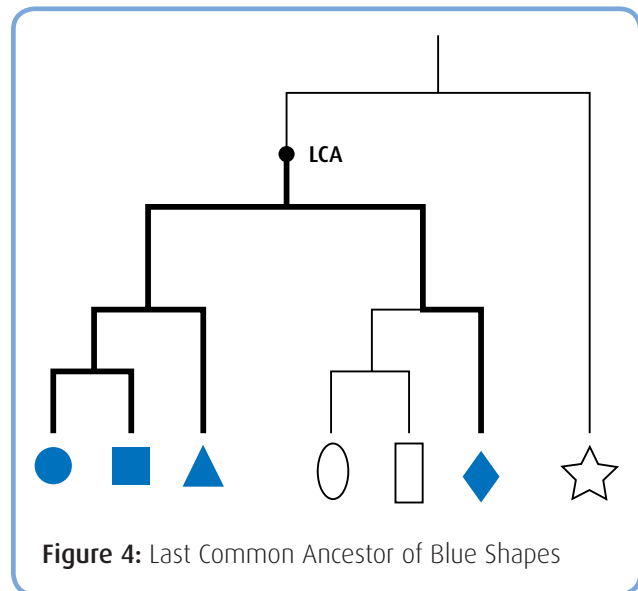

**Figure 4:** Last Common Ancestor of Blue Shapes

may be little or no evidence of this shared ancestor in our nuclear DNA. This is because nuclear DNA gets mixed during sexual reproduction and then further muddled by chromosomal cross-over.

Enter the mitochondrial genome. When scientists restrict their view to a maternal or paternal lineage they can more easily trace back to a maternal or paternal LCA (Figure 5). To do this they use a mathematical model known as Coalesce Theory. This model traces the alleles of a gene back to the LCA's ancestral copy and can accommodate for mutational changes but not recombination, natural selection, or population demographics. Conveniently, DNA inherited from a single parent changes mainly through mutation. Moreover, the rate of change in certain areas of the mtDNA genome is so predictable that it can be used as a molecular clock to estimate when the LCA existed.

Based on current models and extensive sampling of human mtDNA diversity, scientists estimate that our mitochondrial LCA lived in Africa approximately 100,000 to 200,000 years ago (Figure 6). This individual has been nicknamed “mitochondrial Eve” although she was in no way the first human female nor the only female at the time. Rather she was – as one investigator put it – just one lucky mother<sup>1</sup>. This discovery has shaped anthropological theories about the recent African origin



Figure 5: MtDNA LCA Ancestor<sup>3</sup>

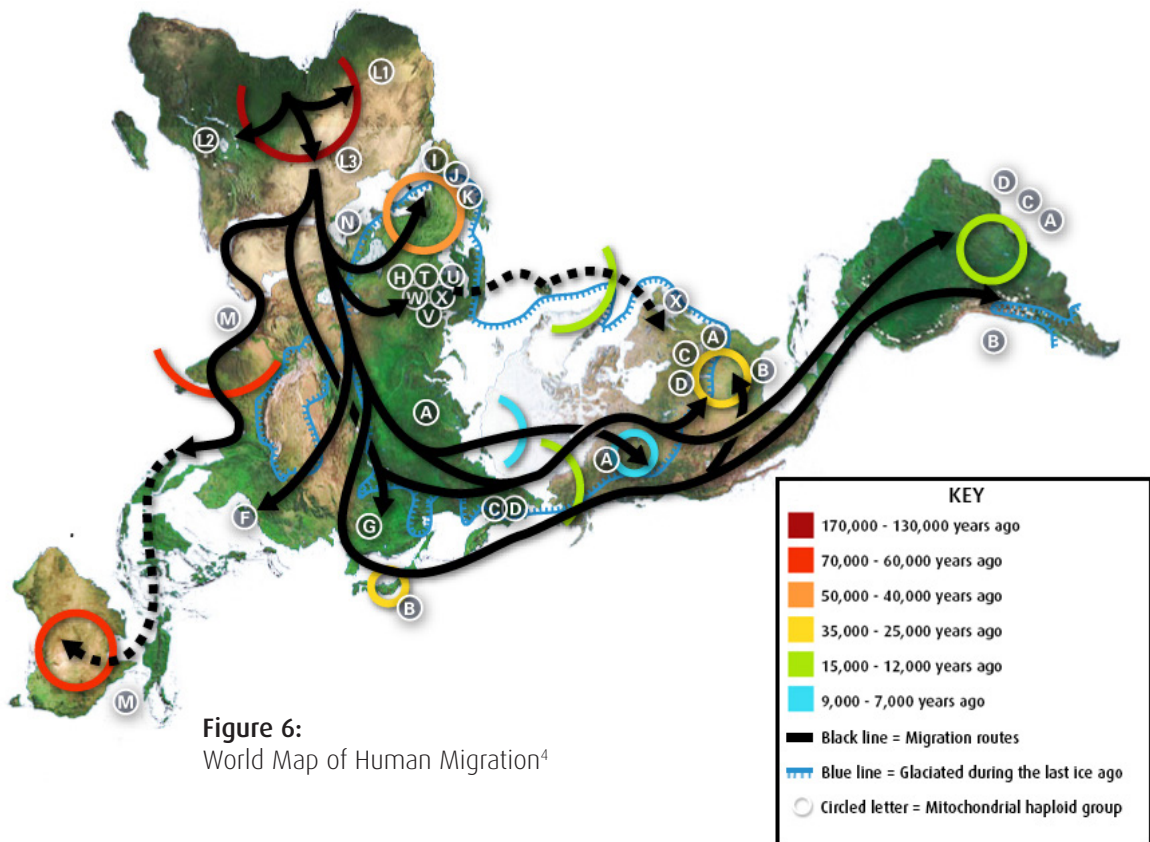

Figure 6:  
World Map of Human Migration<sup>4</sup>

of modern humans. It has also helped in the field of medical genomics where the reconstructed LCA genome provides a base line to better understand modern mitochondrial diseases.

### PCR

To examine mitochondrial DNA, the Polymerase Chain Reaction (PCR) is usually employed. PCR is the systematic amplification of a target DNA sequence using DNA polymerase originally extracted from the heat tolerant bacteria *Thermus aquaticus* (Taq). The method was invented in 1984 by Dr. Kary Mullis at the Cetus Corporation in California and earned him the Nobel Prize in Chemistry in 1993.

Before performing PCR, template DNA is extracted from a biological sample. Because PCR is very sensitive, only a few copies of the DNA are required. In the case of mitochondrial DNA, the numbers are already in your favor as most cells have several hundred to several thousand copies of this genome. In addition, primers – short & synthetic DNA molecules that correspond to the ends of the target sequence and guide the process of amplification – are designed.

To begin, PCR extracted DNA and primers are combined in a buffer that also contains “free” deoxynucleotides,  $MgCl_2$ , and a Taq DNA polymerase. This enzyme, originally purified from a bacterium that inhabits hot springs, is stable at very high temperatures. This mixture of DNA, primers, and buffer is subjected to sequential heating/cooling cycles at three different temperatures in a thermal cycler:

- Denaturation: the mixture is heated to near boiling ( $94^{\circ}C - 96^{\circ}C$ ) to “unzip” (or melt) the target DNA. The high temperature disrupts the hydrogen bonds between the two complementary DNA strands and causes their separation.
- Annealing: the reaction mixture is cooled to  $45^{\circ}C - 65^{\circ}C$ , which allows the primers to base pair with the target DNA sequence. (The exact temperature is determined by the specific sequences of the primers and template DNA.)
- Extension: the temperature is raised to  $72^{\circ}C$ . This is the optimal temperature at which Taq polymerase can add nucleotides to the hybridized primers to synthesize the new complementary strands.

These three steps constitute one PCR “cycle” (Figure 8). Each PCR cycle doubles the amount of the target DNA in less than five minutes. In order to produce enough DNA for analysis, twenty to forty cycles may be required. To simplify this process, a specialized machine, called a “thermal cycler” or a “PCR machine”, was created to rapidly heat and cool the samples. Amplified fragments can then be visualized and sized using gel electrophoresis. They can also be digested by restriction enzymes or sequenced in order to uncover specific nucleotide mutations.

In this experiment, you will extract your own mtDNA, use PCR to amplify two separate regions of the mitochondrial genome (Figure 3), and size these regions using gel electrophoresis. Based on the current theory of a recent mitochondrial eve that existed between 100,000 and 200,000 years ago, the size of these large fragments should be consistent across the class.

#### REFERENCES:

- (1) Gitschier J. 2010. All About Mitochondrial Eve: An Interview with Rebecca Cann. *PLoS Genet* 6(5): e1000959.
- (2) Luo et al. 2018. Biparental Inheritance of Mitochondrial DNA in Humans. *PNAS*. 115 (51) 13039-13044.
- (3) Figure 5 Image: <https://commons.wikimedia.org/wiki/File:MTDNA-MRCA-generations-Evolution.svg>, C. Rottensteiner, used under CC BY-SA 3.0/ Font changed and portions desaturated from original.
- (4) Figure 6 Image: [https://commons.wikimedia.org/wiki/File:World\\_map\\_of\\_prehistoric\\_human\\_migrations.jpg](https://commons.wikimedia.org/wiki/File:World_map_of_prehistoric_human_migrations.jpg) used under CC BY 2.5/ Text added from original.

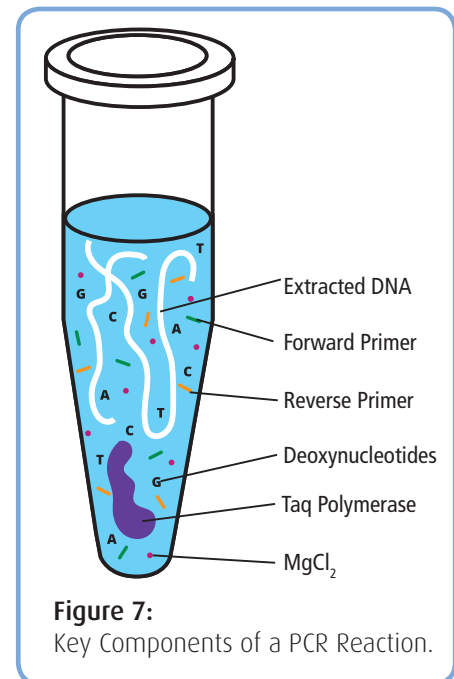



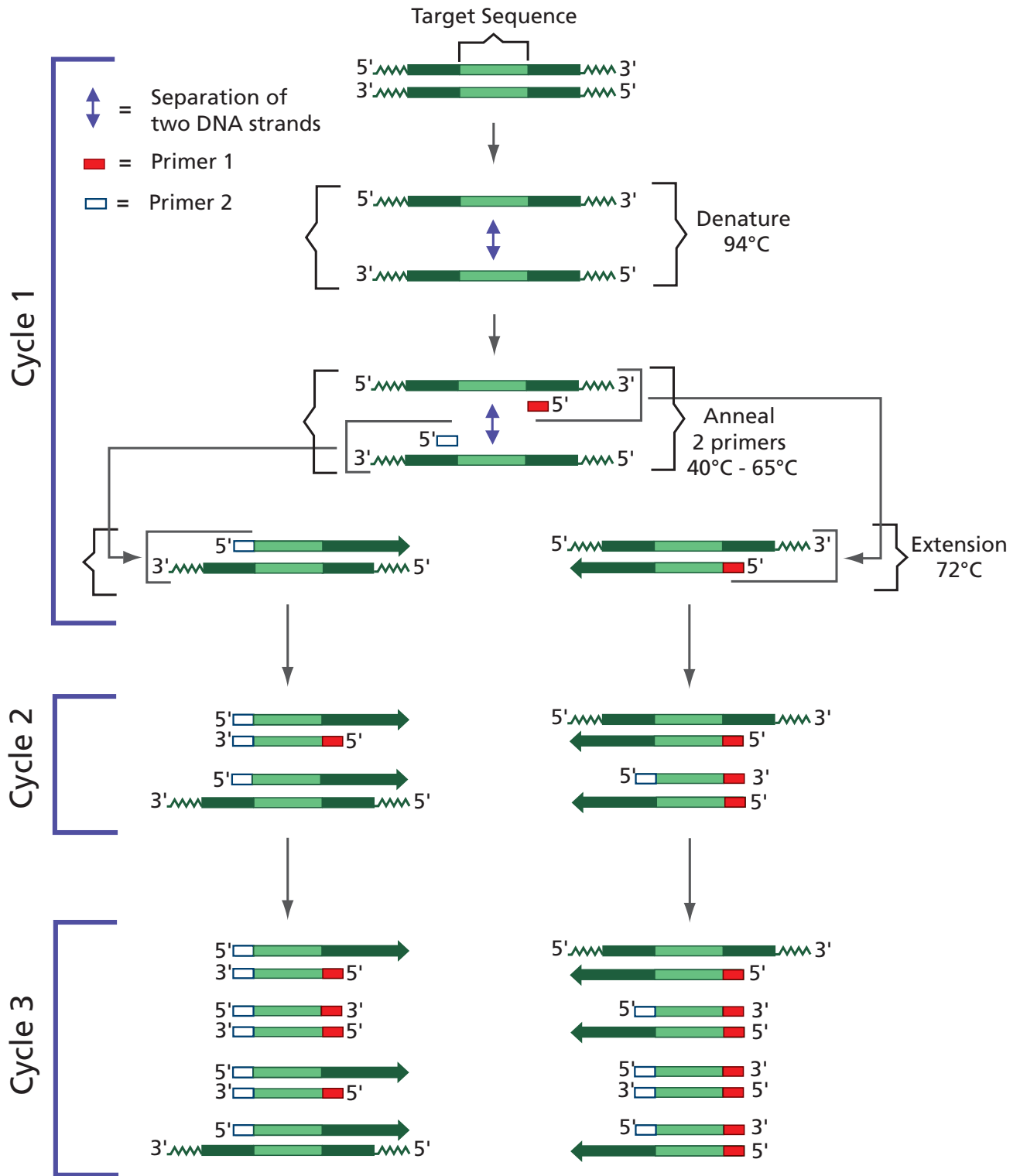

**Figure 8:**  
Polymerase Chain Reaction

## Experiment Overview

### EXPERIMENT OBJECTIVE

In this experiment, students will isolate their mitochondrial DNA and use the Polymerase Chain Reaction (PCR) to amplify two separate regions of the mitochondrial genome. Results are analyzed using agarose gel electrophoresis.

### LABORATORY SAFETY

Be sure to READ and UNDERSTAND the instructions completely BEFORE starting the experiment. If you are unsure of something, ASK YOUR INSTRUCTOR!

- Wear gloves and goggles while working in the laboratory.
- You will be using equipment that can be dangerous if used incorrectly, so use caution.
- Wear protective gloves when working with hot reagents like boiling water and melted agarose.
- DO NOT DRAW SAMPLES INTO PIPETS WITH YOUR MOUTH - USE PIPET PUMPS.
- Always wash hands thoroughly with soap and water after working in the laboratory.
- Contaminated laboratory waste (saliva solution, cup, pipet, etc.) must be disinfected with 15% bleach solution prior to disposal. Be sure to properly dispose any biological samples according to your institutional guidelines.

### LABORATORY NOTEBOOKS

Scientists document everything that happens during an experiment, including experimental conditions, thoughts and observations while conducting the experiment, and, of course, any data collected. Today, you'll be documenting your experiment in a laboratory notebook or on a separate worksheet.

#### Before Starting the Experiment:

- Carefully read the introduction and the protocol. Write a hypothesis that reflects the experiment.
- Predict the results of your experiment.

#### During the Experiment:

- Record your observations or photograph your results.

#### After the Experiment:

- Formulate an explanation from your results.
- Determine what could be changed if the experiment was repeated.
- Write a new hypothesis that would reflect these changes.

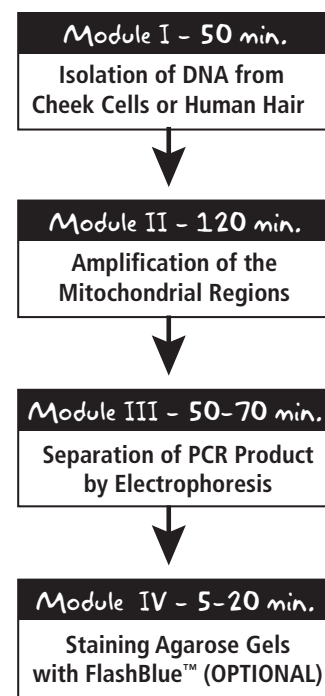

NOTE: Experimental times are approximate.

## Module I-A: Isolation of DNA from Human Cheek Cells

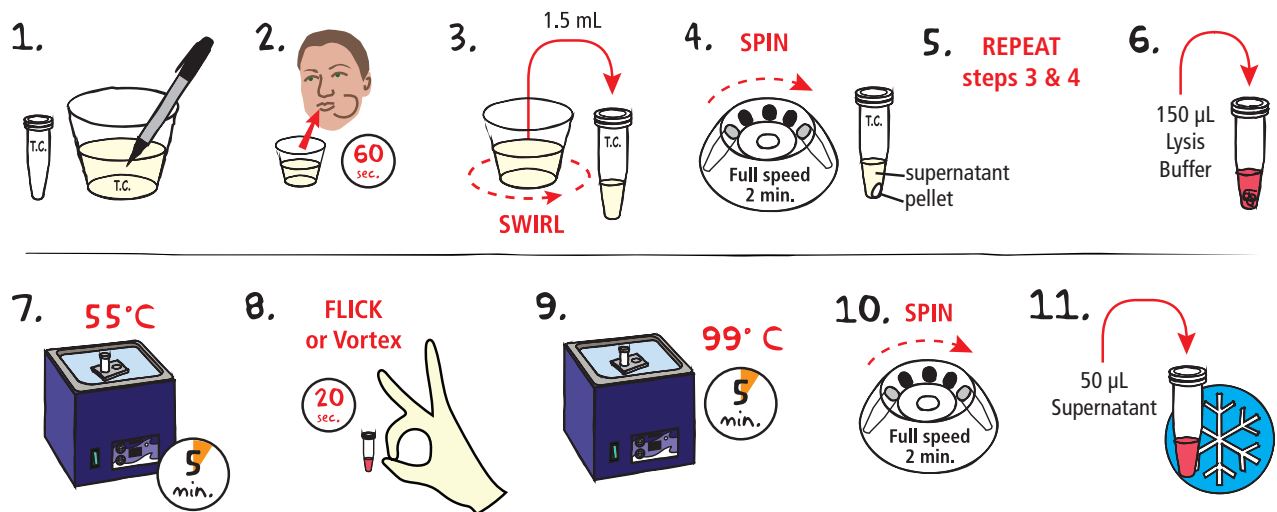

1. **LABEL** an empty 1.5 mL screw top microcentrifuge tube and a cup of saline with your lab group and/or initials.
2. **RINSE** your mouth vigorously for 60 seconds using 10 mL saline solution. **EXPEL** the solution back into the same cup.
3. **SWIRL** the cup gently to resuspend the cells. **TRANSFER** 1.5 mL of the cell solution into the tube with your initials.
4. **CENTRIFUGE** the cell suspension for 2 minutes at full speed to pellet the cells. **POUR** off the supernatant, the liquid above the cell pellet, but **DO NOT DISTURB THE CELL PELLETT!**
5. **REPEAT** steps 3 and 4 once more.
6. **RESUSPEND** the cheek cell pellet in 150 µL lysis buffer by pipetting up and down or by vortexing vigorously. **NOTE: Ensure that the cell pellet is fully resuspended and that no clumps of cells remain.**
7. **CAP** the tube and **PLACE** it in a water bath float. **INCUBATE** the sample in a 55° C water bath for 5 minutes.
8. **MIX** the sample by vortexing or by flicking the tube vigorously for 20 seconds.
9. **INCUBATE** the sample in a 99° C water bath for 5 minutes. **NOTE: Students MUST use screw-cap tubes when boiling samples.**
10. **CENTRIFUGE** the cellular lysate for 2 minutes at full speed.
11. **TRANSFER** 50 µL of the supernatant to a clean, labeled microcentrifuge tube. **PLACE** the tube in ice.

The extracted DNA is now ready for Module II: Amplification of the Mitochondrial Regions. If you are ready to proceed, turn to page 13. Alternatively, the extracted DNA may be stored in the **FREEZER** (-20° C) until needed.

**OPTIONAL STOPPING POINT:**

The extracted DNA may be stored in the freezer (-20° C) until needed.

## Module I-B: Isolation of DNA from Human Hair

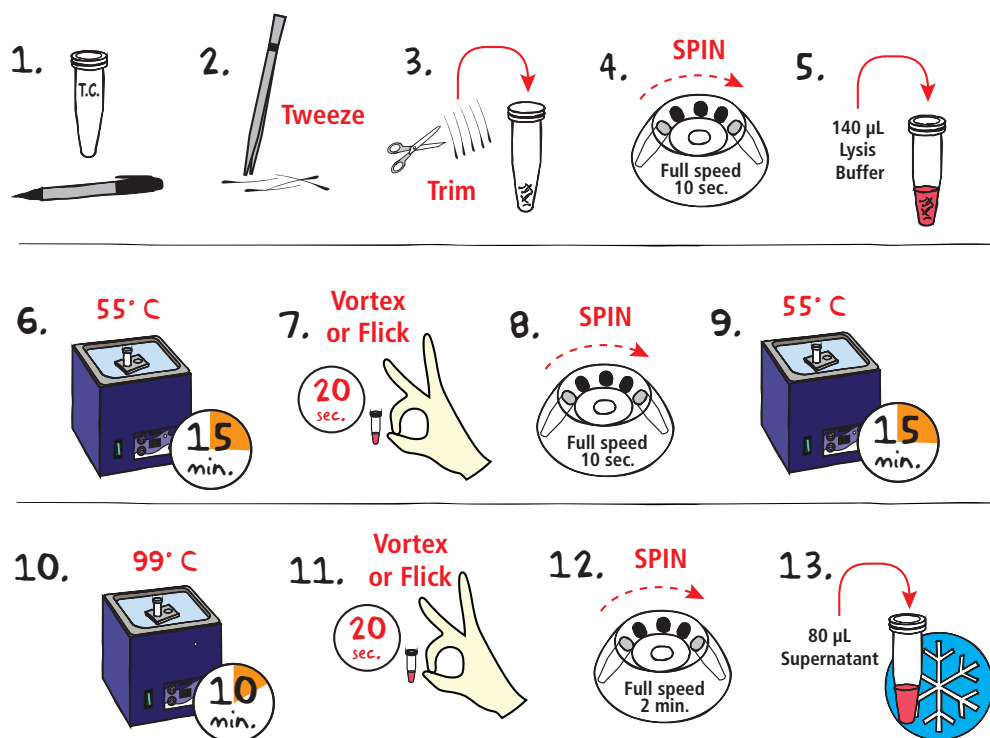

### Warning!

Students should use screw-cap tubes when boiling samples.

### IMPORTANT:

For best results, harvest hairs from the scalp. The root structure from these hairs will be thicker and will yield more DNA than those from the eyebrow.



- LABEL** a 1.5 mL screw top microcentrifuge tube with your initials.
- Using tweezers, **GRASP** 2-3 hair shafts at the base and **PULL** quickly. **COLLECT** at least 5 hairs that include the root and the sheath (a sticky barrel-shaped layer of cells that encircles the root end of the hair).
- Using a clean scalpel or scissors, **TRIM** away any extra hair from the root (leave about 1 cm in length from the root). **TRANSFER** the roots to the labeled tube using forceps.
- CAP** the tube and **CENTRIFUGE** the sample for 10 seconds at full speed to collect the roots at the bottom of the tube.
- ADD** 140 µL lysis buffer to the tube. For best results, completely **IMMERSE** the follicles in the solution.
- CAP** the tube and **PLACE** it in a water bath float. **INCUBATE** the sample in a 55° C water bath for 15 min.
- MIX** the sample by vortexing or flicking the tube vigorously for 20 seconds.
- CENTRIFUGE** the sample for 10 seconds at full speed to collect the roots at the bottom of the tube.
- INCUBATE** the sample at 55° C for an additional 15 min.
- MOVE** the sample to a 99° C water bath. **INCUBATE** for 10 min. Be sure to use screw-cap tubes when boiling samples.
- MIX** the sample by vortexing or flicking the tube vigorously for 20 seconds.
- CENTRIFUGE** the cellular lysate for 2 min. at low speed (6000 rpm).
- TRANSFER** 80 µL of the supernatant to a clean, labeled microcentrifuge tube. **PLACE** tube in ice.
- PROCEED** to Module II: Amplification of the Mitochondrial Regions.

### STEPS 7 & 11:

If a vortex is not available, mix samples by flicking the tube vigorously for 20 seconds.



### OPTIONAL STOPPING POINT:

The supernatant may be stored at -20° C for amplification at a later time.

## Module II: Amplification of the Mitochondrial Regions

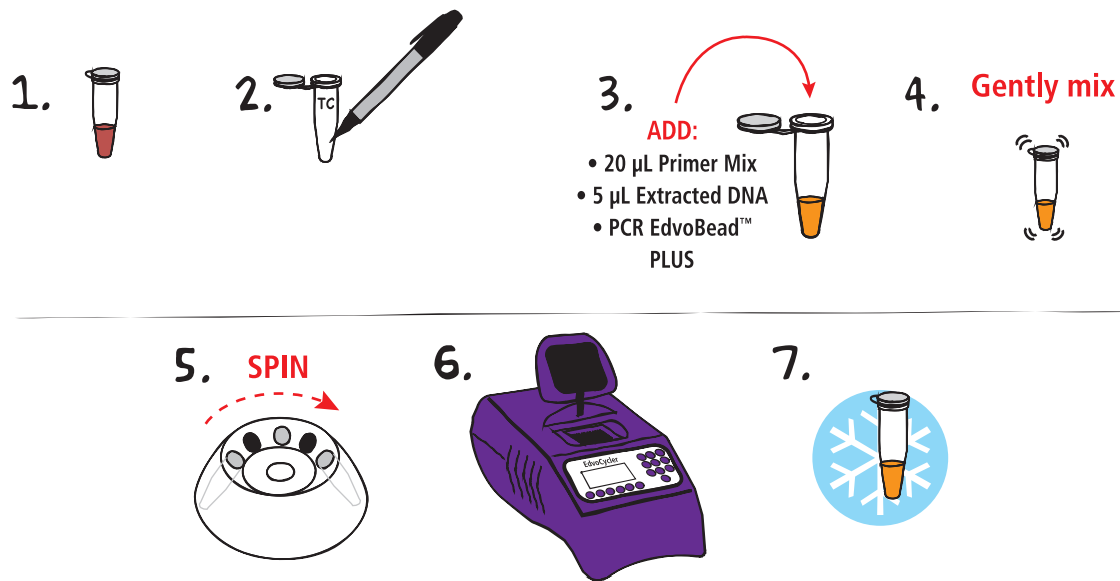

- OBTAIN** the red extracted DNA from Module I.
- LABEL** a fresh 0.2 mL PCR tube with your initials.
- ADD** 20  $\mu$ L Mitochondrial primer mix (yellow), 5  $\mu$ L extracted DNA (red), and a PCR EdvoBead™ PLUS.
- MIX** the PCR sample. Make sure the PCR EdvoBead™ PLUS is completely dissolved. If mixed correctly, the final solution will be light orange.
- CENTRIFUGE** the sample for a few seconds to collect the sample at the bottom of the tube.
- AMPLIFY** the DNA using PCR.  
PCR cycling conditions:
  - Initial denaturation 94° C for 1 minute
  - 94° C for 30 seconds
  - 55° C for 30 seconds
  - 72° C for 2 minutes
 } 25 cycles
- Final Extension 72° C for 1 minute
- After PCR, **PLACE** the tubes on ice. **PROCEED** to Module III: Separation of PCR Products by Electrophoresis.



### OPTIONAL STOPPING POINT:

The PCR samples may be stored at -20° C for electrophoresis at a later time.

### NOTE:

*This kit contains enough Control DNA for 6 reactions. We strongly recommend running all 6 control reactions to ensure the PCR was successful.*

The positive control contains primers, template DNA and PCR components, and is ready for PCR amplification.



### NOTE:

PCR Cycling Conditions have changed. Please review your PCR program before performing the experiment.

## Module III: Separation of PCR Products by Electrophoresis

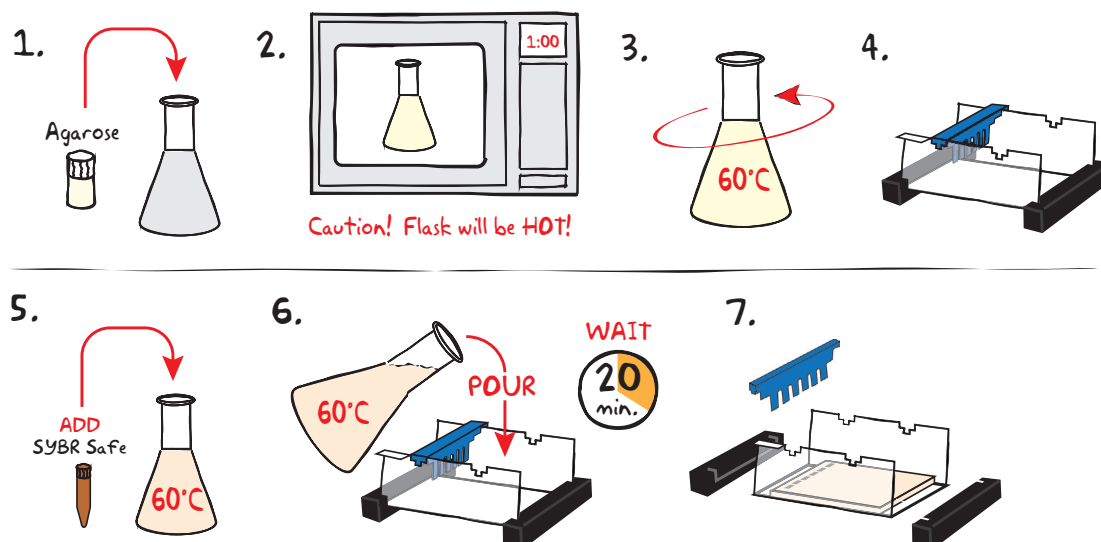

### PREPARING THE AGAROSE GEL WITH SYBR® SAFE STAIN

- MIX** the agarose powder with 1X TBE buffer in a 250 mL flask (see Table A).
- DISSOLVE** the agarose powder by boiling the solution. **MICROWAVE** the solution on high for 1 minute. Carefully **REMOVE** the flask from the microwave and **MIX** by swirling the flask. Continue to **HEAT** the solution in 15-second bursts until the agarose is completely dissolved (the solution should be clear like water).
- COOL** agarose to 60° C by carefully swirling the flask to promote even dissipation of heat.
- While agarose is cooling, **SEAL** the ends of the gel-casting tray with the rubber end caps. **PLACE** the comb in the appropriate notch.
- Before casting the gel, **ADD** SYBR® Safe concentrate to the cooled molten agarose and swirl the flask to mix (see Table A).
- POUR** the cooled agarose solution into the prepared gel-casting tray. The gel should thoroughly solidify within 20 minutes. The gel will stiffen and become less transparent as it solidifies.
- REMOVE** the end caps and comb. Take particular care when removing the comb to prevent damage to the wells.



Wear gloves and safety goggles

#### IMPORTANT:

7 x 7 cm gels are recommended. Each gel can be shared by 4-5 students. Place well-former template (comb) in the first set of notches.

If you are unfamiliar with agarose gel prep and electrophoresis, detailed instructions and helpful resources are available at [www.edvotek.com](http://www.edvotek.com)



#### OPTIONAL STOPPING POINT:

Gels can be stored overnight submerged in electrophoresis buffer, in the fridge, and protected from light.

Table A  
Individual 2.0% UltraSpec-Agarose™ Gel with SYBR® Safe Stain

Size of Gel Casting tray	1X TBE Buffer	+ Amt of Agarose	= TOTAL Volume	ADD SYBR® (Step 5)
7 x 7 cm	25 mL	0.5 g	25 mL	25 µL
7 x 14 cm	50 mL	1.0 g	50 mL	50 µL

## Module III: Separation of PCR Products by Electrophoresis, continued

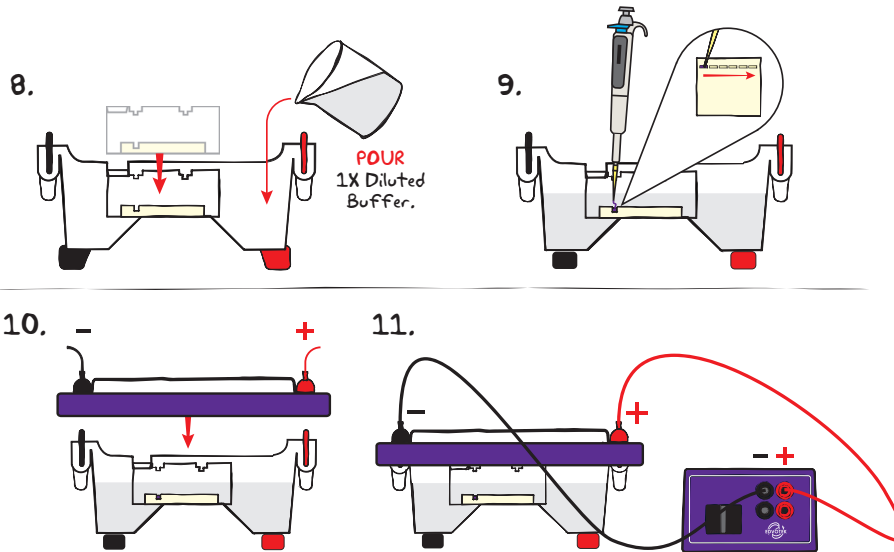

### Reminder:

Before loading the samples, make sure the gel is properly oriented in the apparatus chamber.



Wear gloves and safety goggles

### RUNNING THE GEL

- PLACE** the gel (on the tray) into an electrophoresis chamber. **COVER** the gel with 1X TBE electrophoresis buffer (See Table B for recommended volumes). The gel should be completely submerged.
- Using Table 1 as a guide, **LOAD** the entire sample (25  $\mu$ L) into the wells in consecutive order.
- CHECK** that the gel is properly oriented, then **PLACE** safety cover onto the chamber. Remember, the DNA samples will migrate toward the positive (red) electrode.
- CONNECT** the leads to the power source and **PERFORM** electrophoresis (See Table C for time and voltage guidelines).
- After electrophoresis is complete, **REMOVE** the gel and casting tray from the electrophoresis chamber.



### OPTIONAL STOPPING POINT:

Gels can be stored for several days. Protect from light, refrigerate, and keep hydrated by storing each gel in a water-tight plastic bag with a small amount of electrophoresis buffer.

Table 1: Sample Table

Lane	Recommended	Sample Name
1	EdvoQuick™ DNA Ladder	
2	Control DNA*	
3	Student #1	
4	Student #2	
5	Student #3	
6	Student #4	

\* Optional, or additional student sample.

Table B  
1x TBE Electrophoresis Buffer (Chamber Buffer)

EDVOTEK Model #	Total Volume Required
M6+ & M12 (new)	300 mL
M12 (classic)	400 mL
M36	1000 mL

Table C  
Time and Voltage Guidelines (2.0% Agarose Gels)

Volts	Time: 7 x 7 cm gel ~4.0 cm migration	Time: 7 x 14 cm gel ~6.5 cm migration
125	30 min.	60 min.
70	60 min.	120 min.
50	90 min.	150 min.

### Module III: Separation of PCR Products by Electrophoresis, continued

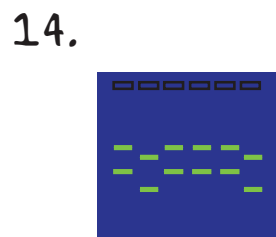
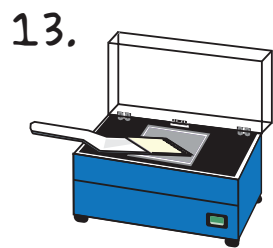

#### VISUALIZING THE SYBR® GEL

13. **SLIDE** the gel off the casting tray onto the viewing surface of the transilluminator and turn the unit on. **ADJUST** the brightness to the desired level to maximize band visualization. DNA should appear as bright green bands on a dark background.
14. **PHOTOGRAPH** the results.
15. **REMOVE** and **DISPOSE** of the gel and **CLEAN** the transilluminator surfaces with distilled water.

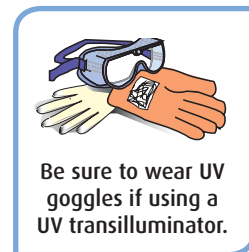



## Module IV: Staining Agarose Gel with FlashBlue™ Stain (OPTIONAL)

FlashBlue™ Stain is a simple and effective visible DNA stain that can be used as an alternative, or in addition to, UV-reactive DNA stains like SYBR® Safe. **IF staining with both SYBR® Safe and Flash Blue, you must examine and record the SYBR® Safe bands before beginning the FlashBlue™ Staining.**

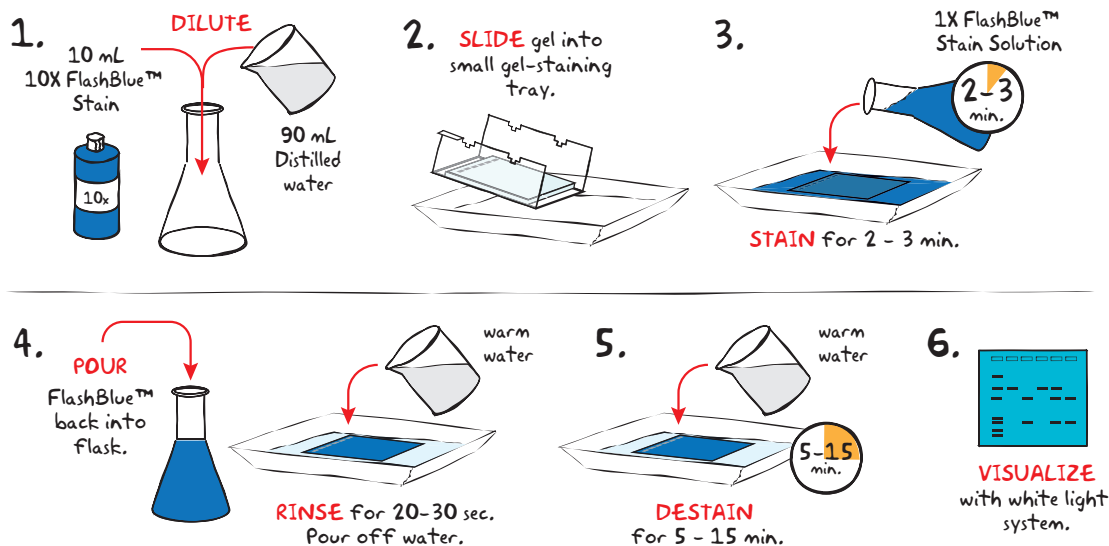

- DILUTE** 10 mL of 10X concentrated FlashBlue™ with 90 mL of distilled water in a flask. **MIX** well.
- REMOVE** the agarose gel and casting tray from the electrophoresis chamber. **SLIDE** the gel off the casting tray into a small, clean gel-staining tray.
- COVER** the gel with the 1X FlashBlue™ stain solution. **STAIN** the gel for 2-3 minutes. For best results, use an orbital shaker to gently agitate the gel while staining. **STAINING THE GEL FOR LONGER THAN 3 MINUTES WILL REQUIRE EXTRA DESTAINING TIME.**
- POUR** the 1X FlashBlue™ back into the flask (the stain can be reused). **COVER** the gel with warm water (40-45° C). Gently **RINSE** the gel for 20-30 seconds. **POUR** off the water.
- COVER** the gel with clean, warm water (40-45° C). **DESTAIN** for 5-15 minutes with gentle shaking (longer periods will yield better results). DNA bands will start to appear after 5 minutes of destaining. Changing the water frequently will accelerate destaining.
- Carefully **REMOVE** the gel from the destaining liquid. **VISUALIZE** results using a white light visualization system. DNA will appear as dark blue bands on a light blue background.



### ALTERNATIVE FLASHBLUE™ STAINING PROTOCOL:

- DILUTE** 1 mL of 10X FlashBlue™ stain with 499 mL distilled water.
- COVER** the gel with diluted FlashBlue™ stain.
- SOAK** the gel in the staining liquid for at least three hours. For best results, stain gels overnight.
- Carefully **REMOVE** the gel from the staining liquid. **VISUALIZE** results using a white light visualization system. DNA will appear as dark blue bands on a light blue background.

1.800.EDVOTEK • Fax 202.370.1501 • [info@edvotek.com](mailto:info@edvotek.com) • [www.edvotek.com](http://www.edvotek.com)

## Study Questions

---

1. How are mitochondria different from other organelles inside the cell? What is one origin theory for mitochondria that explains these traits?
2. Why might mitochondrial DNA be a better tool for deciphering our species' past history than nuclear DNA?
3. Who is Mitochondrial Eve? Do all species have a Mitochondrial Eve? Do humans have any other LCAs?

# Instructor's Guide

## OVERVIEW OF INSTRUCTOR'S PRELAB PREPARATION:

This section outlines the recommended prelab preparations and approximate time requirement to complete each prelab activity.

Preparation For:	What to do:	When:	Time Required:
<b>Module I: Isolation of DNA from Hair or Cheek Cells</b>	Prepare and aliquot various reagents (saline).	Up to one day before performing the experiment.	30 min.
	Prepare and aliquot Lysis Buffer.	Prepare on the day the students will be performing the experiment OR freeze for up to one week.	15 min.
	Equilibrate water baths at 55° C and boiling.	Anytime before performing the experiment.	5 min.
<b>Module II: Amplification of the Mitochondrial Regions</b>	Prepare and aliquot various reagents (Primer, control, ladder, etc.).	One day to 30 min. before performing the experiment.	30 min.
	Program Thermal Cycler.	Anytime before performing the experiment.	15 min.
<b>Module III: Separation of PCR Products by Electrophoresis</b>	Prepare TBE buffer and dilute SYBR® Safe Stain.	Up to one week before performing the experiment.	45 min.
	Prepare molten agarose and pour gel.		
<b>Module IV: Staining Agarose Gels with FlashBlue™ (OPTIONAL)</b>	Prepare staining components.	Up to 10 min. before the class period.	10 min.

Red = Prepare immediately before module.
  Yellow = Prepare shortly before module.
  Green = Flexible / prepare up to a week before the module.

### NOTE:

The PCR cycling conditions may have changed. Before running the experiment, confirm that the program matches the settings below:

- Initial denaturation 94° C for 1 minutes
  - 94° C for 30 seconds
  - 55° C for 30 seconds
  - 72° C for 2 minutes
  - Final Extension 72° C for 1 minute
- } 25 cycles

## Pre-Lab Preparations: Module I

### ISOLATION OF DNA

**NOTE:** For Module I-A, Saline solution **MUST** be used for cheek cell wash. Sports drinks will inhibit amplification of DNA by Polymerase Chain Reaction in Module II. If you have used sports drinks for the cheek cell wash, please **DISCARD** the samples and **REPEAT** the DNA extraction with saline solution

**DISINFECTING LABORATORY MATERIALS:** Contaminated laboratory waste (saliva solution, cup, pipette, etc.) must be disinfected with 15% bleach solution prior to disposal. Be sure to properly dispose of any biological samples according to your institutional guidelines.

#### Preparation of the Saline Solution (For Module I-A ONLY):

1. To prepare the saline solution, dissolve all 8 salt packets (~4 g) in 500 mL of drinking water. Cap and invert bottle to mix.
2. Aliquot 10 mL of saline solution per cup. Distribute one cup per student.

#### Preparation of the Lysis Buffer (For Module I-A or I-B)

**NOTE:** The Lysis Buffer must be mixed with Proteinase K before performing the experiment. Once prepared, the Lysis should be used the same day or frozen.

1. Add 100  $\mu$ L of Universal DNA buffer (A) to the tube of Proteinase K and allow the sample to hydrate for several minutes. After the sample is hydrated, pipet up and down several times to thoroughly mix the material.
2. Transfer the entire amount of the rehydrated Proteinase K solution to a 15 mL conical tube containing an additional 4 mL of Universal DNA buffer (A).
3. Invert the tube several times to mix. Label this tube "Lysis Buffer".

**NOTE:** The Lysis Buffer should be red and free of any undissolved clumps.

4. Aliquot 300  $\mu$ L of Lysis Buffer into 13 labeled microcentrifuge tubes to be shared by pairs of students.

**NOTE:** At this point, the Lysis Buffer should be stored on ice for use within the same day (up to 6 hours) or frozen.

5. Distribute one tube of "Lysis Buffer" to each student pair. If frozen, the Lysis Buffer can be quickly thawed in a 37° C water bath or by students warming the tube in their hands.

**DISINFECTING LABORATORY MATERIALS:** Contaminated laboratory waste (saliva solution, cup, pipet, etc.) must be disinfected with 15% bleach solution prior to disposal. Be sure to properly dispose any biological samples according to your institutional guidelines.

#### Prepare Water Baths (For Module I-A or I-B):

- Equilibrate water baths at 55° C and boiling.

#### FOR MODULE I-A

##### Each student receives:

- One cup containing 10 mL of saline solution
- One screw-cap tube
- One microcentrifuge tube

##### Reagents to be shared by two students:

- 300  $\mu$ L Lysis buffer
- 15% bleach solution

#### FOR MODULE I-B

##### Each student receives:

- One screw-cap tube
- One microcentrifuge tube

##### Reagents to be shared by two students:

- 300  $\mu$ L Lysis buffer

#### Warning !!

Remind students to only use screw-cap tubes when boiling their DNA samples. The snap-top tubes can potentially pop open and cause injury.

## Pre-Lab Preparations: Module II

### AMPLIFICATION THE MITOCHONDRIAL REGIONS

The PCR primers are provided as a lyophilized mixture that must be rehydrated by the instructor before performing the experiment. The PCR EdvoBeads™ PLUS can be distributed prior to setting up the PCR – students or instructors can gently transfer the PCR EdvoBeads™ PLUS using gloved hands. Alternatively, beads can be gently "poured" from the vial into individual PCR tubes. After distributing the beads, it is important to close the PCR tubes securely to prevent the beads from absorbing moisture and becoming hard to resuspend prior to the experiment. **NOTE: The PCR EdvoBeads™ PLUS are fragile, use care to not crush the beads while transferring to a PCR tube.**

#### FOR MODULE II

##### Each student receives:

- One 0.2 mL PCR tube and PCR EdvoBead™ PLUS

##### Reagents to be shared by two students:

- 50 µL Diluted Primer Mix



This kit features the NEW EDVOTEK® LyphoControl™ and LyphoPrimer™. The reagents are also color coded so that a correctly assembled PCR reaction should appear orange in color.

#### Preparation of the Primer Mix

1. Thaw the TE Buffer (B) and mix well.
2. Ensure that the lyophilized solid is at the bottom of the LyphoPrimer™ tube (C). If not, centrifuge the tube at max speed for 10 seconds.
3. Add 1 mL of TE Buffer (B) to the tube of Mitochondrial Primer Mix. Cap tube and mix.
4. Aliquot 50 µL of the diluted Mitochondrial Primer Mix into 13 labeled microcentrifuge tubes.
5. Distribute one tube of diluted Mitochondrial Primer Mix to each student pair. The tubes can be placed on ice or in a 4° C refrigerator until needed.

#### Preparation of the PCR Control Mix

**NOTE: This kit contains enough Control DNA for 6 reactions. We strongly recommend running all 6 control reactions to ensure the PCR was successful.**

1. Ensure that the lyophilized solid is at the bottom of the LyphoControl™ tube (D). If not, centrifuge the tube at max speed for 10 seconds.
2. Add 160 µL of TE Buffer (B) to the tube containing the LyphoControl™ (D). Pipet up and down to mix.
3. Dispense 25 µL of the diluted Control reaction for each control reaction. **NOTE: The LyphoControl™ already contains all necessary PCR components and does not need a PCR Edvobead™ PLUS. Once diluted, the LyphoControl™ is ready to be amplified by PCR alongside student samples, if there is room in the thermal cycler, or can be run prior to the student experiment and stored at -20° C until needed. One 25 µL LyphoControl™ reaction should be run on every student gel to ensure the PCR was successful.**

#### PCR Amplification

The thermal cycler should be programmed as outlined in Module II in the Student's Experimental Procedure.

- Accurate temperatures and cycle times are critical. A pre-run for one cycle (takes approximately 3 to 5 min.) is recommended to check that the thermal cycler is properly programmed.
- For thermal cyclers that do not have a heated lid, it is necessary to place a layer of wax or mineral oil above the PCR reactions in the microcentrifuge tubes to prevent evaporation. Visit [www.edvotek.com](http://www.edvotek.com) for instructions.



#### NOTE:

PCR Cycling Conditions have changed. Please review your PCR program before performing the experiment.

## Pre-Lab Preparations: Module III

### SEPARATION OF PCR PRODUCTS BY ELECTROPHORESIS

#### Preparation of TBE Electrophoresis Buffer:

For this experiment, we recommend preparing the 1X TBE Electrophoresis Buffer in bulk for sharing by the class. Unused diluted buffer can be used at a later time. See Appendix B for instructions.

#### SYBR® Safe Stain Preparation:

Prepare diluted SYBR® Safe by adding 250 µL of 1X TBE buffer to the tube of SYBR® Safe and tapping the tube several times to mix. Diluted SYBR® Safe will be used during agarose gel preparation.

#### Preparation of Agarose Gels:

This experiment requires one 2.0% agarose gel per 4 students. **A 7 x 7 cm gel is recommended.** You can choose whether to prepare the gels in advance or have the students prepare their own. Allow approximately 30-40 minutes for this procedure

#### Individual Gel Preparation

Each student group can be responsible for casting its own individual gel prior to conducting the experiment (see Module III in the Student's Experimental Procedure). Students will need 1X TBE buffer and agarose powder. In addition, each 7 x 7 cm gel will need 25 µL of diluted SYBR® Safe Stain.

#### Batch Gel Preparation

To save time, a larger quantity of agarose solution can be prepared for sharing by the class. See Appendix B for instructions.

#### Preparing Gels in Advance

Gels may be prepared ahead and stored for later use. Solidified gels can be stored for up to 1 week in the refrigerator in water-tight bags with a small amount of buffer to prevent drying. We recommend adding 2 mL of buffer to the bag; excess buffer can lead to diffusion of SYBR® Safe out of the gels.

Do not store gels at -20° C as freezing will destroy them.

Gels that have been removed from their trays for storage should be "anchored" back to the tray with a few drops of molten agarose before being placed into the tray. This will prevent the gels from sliding around in the trays and the chambers.

#### Additional Materials

Each 2.0% gel should be loaded with the EdvoQuick™ DNA ladder, a Control DNA reaction, and PCR reactions from 4 students.

- Pipette 30 µL of the EdvoQuick™ DNA ladder (E) into labeled microcentrifuge tubes and distribute one tube per gel/student group.

#### NOTE:

Accurate pipetting is critical for good experiment results. This experiment is designed for students who have had previous experience with micropipetting techniques and agarose gel electrophoresis.

If students do not know how to use micropipettes, we recommend performing Cat. #S-44, Micropipetting Basics or Cat. #S-43, DNA DuraGel™ prior to conducting this advanced level experiment.

#### FOR MODULE III

##### Each group receives:

- 1X TBE Buffer
- UltraSpec-Agarose™ Powder
- Tube of Diluted SYBR® Safe (25 µL)
- EdvoQuick™ DNA Ladder (30 µL)

#### NOTE:

QuickGuide instructions and guidelines for casting various agarose gels can be found on our website.

[www.edvotek.com/quick-guides](http://www.edvotek.com/quick-guides)

Cat. #557

#### TruBlu™ LED Transilluminator

The all-new TruBlu™ LED Transilluminator utilizes blue light to view DNA gels stained with SYBR® Safe, thus eliminating the need for UV light or ethidium bromide. The spacious viewing area fits multiple agarose gels. And the high intensity control and orange lid ensure superior visualization.

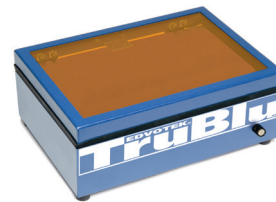

#### Features:

- 14.5 x 18 cm viewing area
- Blue light intensity control
- Orange contrast lid
- Durable steel casing
- Made in the USA

## Pre-Lab Preparations: Module IV (OPTIONAL)

### STAINING AGAROSE GELS WITH FLASHBLUE™ (OPTIONAL)

FlashBlue™ can be used as an alternative or in addition to SYBR® Safe in this experiment. If only staining with FlashBlue™, you can omit SYBR® Safe from the gel preparation. However, FlashBlue™ is less sensitive than SYBR® Safe and will take a longer time to obtain results. Alternatively, gels can be visualized first with SYBR® Safe and then with FlashBlue™.

Agarose gels can be stained with diluted FlashBlue™ for 5 minutes and destained for only 20 minutes. For the best results, leave the gel in liquid overnight. This will allow the stained gel to develop in the destaining solution, resulting in dark blue DNA bands that contrast with a uniformly light blue background. A white light box (Cat. #552) is recommended for visualizing gels stained with FlashBlue™.

- FlashBlue™ stained gels may be stored in the refrigerator for several weeks. Place gel in a small ziplock storage bag with 1-2 mL of electrophoresis buffer and store until needed. Bands may fade slightly with time.
- Destained gels should be discarded in the garbage and destaining solutions should be disposed of down the drain.

#### Photodocumentation of DNA (Optional)

Once the gels are stained, you may wish to photograph your results. There are many different photodocumentation systems available, including digital systems that interface directly with computers. Specific instructions will vary depending upon the type of photodocumentation system you are using.



#### FOR MODULE IV

##### Each group receives:

- 10 mL 10X concentrated FlashBlue OR 100 mL 1x diluted FlashBlue
- Small plastic tray or weight boat
- Distilled or deionized water

## Experiment Results and Analysis

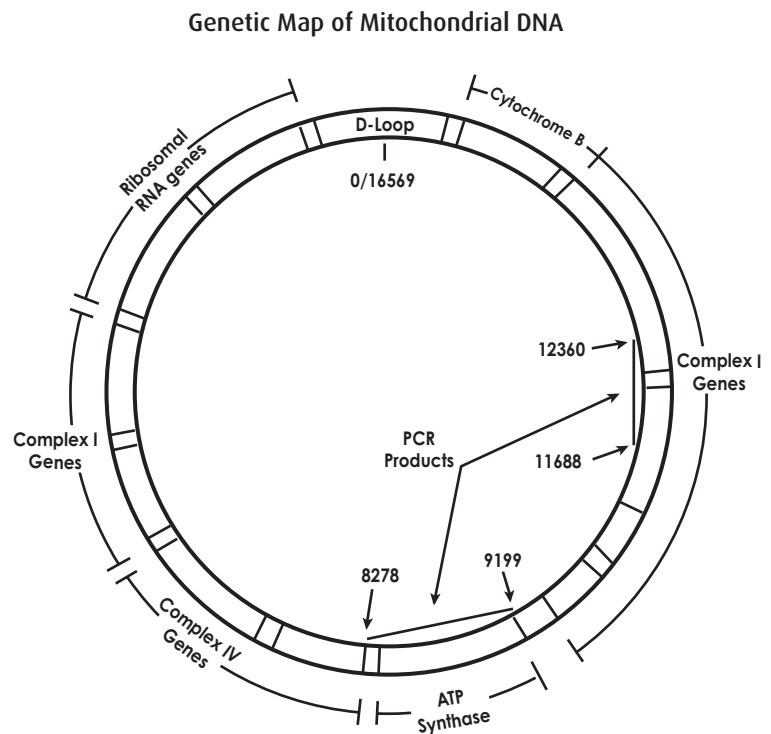
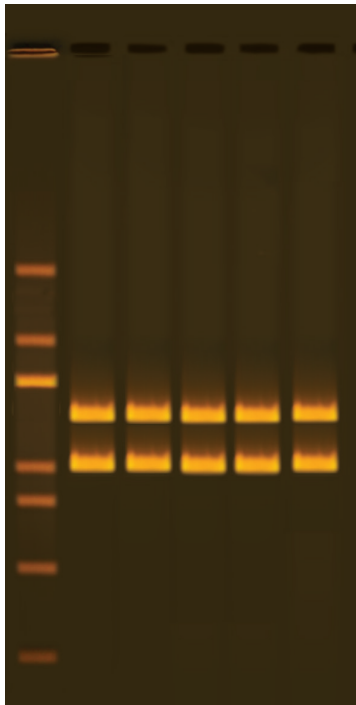

Amplification of these regions should yield PCR products of 921 and 672 base pairs for all students. The continuity of size across these large mtDNA regions supports the theory of a recent (100,000 to 200,000 years before present) mitochondrial eve as over this time frame mutation involving large insertions or deletions are unlikely to have occurred. (Smaller changes in single nucleotides do occur over this time frame and are used for molecular clock dating but require additional sequencing or restriction enzyme analysis steps.)

**Note** – Depending on the PCR conditions used, a diffuse, small-molecular weight band, known as a "primer dimer", may be present below the 200 bp marker. This is a PCR artifact and can be ignored. Other minor bands may also appear due to nonspecific primer binding and the subsequent amplification of these sequences.

### Includes EDVOTEK's All-NEW EdvoQuick™ DNA Ladder

- Better separation
- Easier band measurements
- No unused bands

EdvoQuick™ DNA ladder sizes:  
2640, 1400, 1100, 700, 600, 400, 200

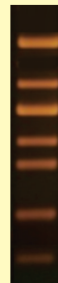



**Please refer to the kit  
insert for the Answers to  
Study Questions**

# Appendices

- A EDVOTEK® Troubleshooting Guide
- B Bulk Preparation of Electrophoresis Buffer and Agarose Gels

Safety Data Sheets can be found on our website:  
[www.edvotek.com/safety-data-sheets](http://www.edvotek.com/safety-data-sheets)

## EDVO-TECH Service

**1.800.EDVOTEK**

Mon. - Fri. 8am-5:30pm EST



### Please Have the Following Info:

- Product Number & Description
- Lot Number on Box
- Order/Purchase Order #
- Approx. Purchase Date

Fax: 202.370.1501 • [info@edvotek.com](mailto:info@edvotek.com) • [www.edvotek.com](http://www.edvotek.com)

**[www.edvotek.com](http://www.edvotek.com)**

- Online Catalog
- Order Products
- Experiment Protocols
- Tech Support
- Resources!



## Appendix A

### EDVOTEK® Troubleshooting Guides

#### DNA EXTRACTION

PROBLEM:	CAUSE:	ANSWER:
There is no cell pellet after centrifuging the cheek cell suspension.	Not enough cheek cells in suspension.	Mouth must be vigorously rinsed for at least 60 sec. to harvest loose cheek cells. Pool additional suspension and repeat centrifuge step until a cell pellet is seen.
	Sample not centrifuged fast enough.	Spin cells at maximum speed (17,000 x g) for 2 min. If your centrifuge does not reach this speed, spin at highest available speed for 4 min.
I was not able to extract DNA from hair.	Not enough hairs used for extraction.	Use at least five hairs for the DNA extraction.
	No follicle was present on hair shaft.	The best place to collect hairs for this experiment is the head. Pick hair follicles which have a bulbous base (sheath cells).
Poor DNA Extraction.	Samples not mixed well enough during extraction.	In addition to flicking the tube, vortex or pipet up and down to mix the sample.
	Proteinase K inactive because it was prepared too far in advance.	Prepare Proteinase K within one hour of use.
	Water baths not at proper temperature.	Use a thermometer to confirm water bath set point.
	Not enough DNA.	Try cheek cell extraction. Final DNA concentrations are usually higher.
The extracted DNA is very cloudy.	Cellular debris from pellet transferred to tube.	Centrifuge the sample again and move supernatant to a fresh tube. Do not touch the pellet.
	Cellular debris not separated from supernatant.	Centrifuge the sample again. If possible, centrifuge at a higher speed. Move cleared supernatant to a fresh tube.

## Appendix A

### EDVOTEK® Troubleshooting Guides

#### PCR AND ELECTROPHORESIS

PROBLEM:	CAUSE:	ANSWER:
There is very little liquid left in tube after PCR.	Sample has evaporated.	Make sure the heated lid reaches the appropriate temperature.
		If your thermal cycler does not have a heated lid, overlay the PCR reaction with wax or mineral oil.
	Pipetting error.	Make sure students close the lid of the PCR tube properly.
The ladder, control DNA, and student PCR products are not visible on the gel.	The gel was not prepared properly.	Students should pipette 20 $\mu$ L primer mix and 5 $\mu$ L extracted DNA into the 0.2 mL tube.
		Ensure that the electrophoresis buffer was correctly diluted.
		Gels of higher concentration (> 0.8%) require special attention when melting the agarose. Make sure that the solution is completely clear of "clumps" and glassy granules before pouring gels.
	The proper buffer was not used for gel preparation. Make sure to use 1x Electrophoresis Buffer.	
The gel was not stained properly.	Ensure that SYBR® Safe Stain was added to the gel. Repeat Staining.	
	Contact the manufacturer of the electrophoresis unit or power source.	
Malfunctioning electrophoresis unit or power source.	Repeat staining protocol.	
After staining the gel, the DNA bands are faint.	The gel was not stained for a sufficient period of time.	Repeat staining protocol.
After staining with FlashBlue™, the gel background is very dark.	The gel needs to be destained longer.	Submerge the gel in distilled or deionized water. Allow the gel to soak for 5 minutes.
After staining with FlashBlue™, the ladder and control PCR products are visible on the gel but some student samples are not present.	Student DNA sample was not concentrated enough.	Poor DNA extraction. Repeat Module I (Isolation of DNA from Human Cheek Cells).
	Student DNA sample was degraded.	If DNA is not used right after extraction, store sample at -20°C.
	Wrong volumes of DNA and primer added to PCR reaction.	Practice using micropipettes.
Some student samples have more/less amplification than others.	Concentration of DNA varies by sample.	There is an inherent variability in the extraction process.
Low molecular weight band in PCR samples.	Primer dimer.	Low concentration of extracted DNA in PCR reaction.
DNA bands were not resolved.	To ensure adequate separation, make sure the tracking dye migrates at least 3.5 cm on 7 x 7 cm gels and 6 cm on 7 x 14 cm gels.	Be sure to run the gel the appropriate distance before staining and visualizing the DNA.
DNA bands fade when gels are kept at 4°C.	DNA stained with FlashBlue™ may fade with time.	Re-stain the gel with FlashBlue™.

## Appendix B

### Bulk Preparation of Electrophoresis Buffer and Agarose Gels

To save time, the electrophoresis buffer and agarose gel solution can be prepared in larger quantities that the whole class can share. Leftover diluted buffer can be used at a later time and solidified agarose gel solution can be remelted.

#### BULK 1X TBE ELECTROPHORESIS BUFFER

For this experiment, we recommend preparing the 1X TBE Electrophoresis Buffer in bulk for sharing by the class. Unused diluted buffer can be used at a later time.

1. Measure 3.7 L of distilled or deionized water and place in a large vessel. (**NOTE: If using purchased water in a gallon jug, remove and discard 80 mL water.**)
2. Add the entire amount of TBE Electrophoresis Buffer powder to the vessel and mix well.
3. Label the vessel as "1X TBE Electrophoresis Buffer".
4. Use within 60 days of preparation.

#### BATCH AGAROSE GELS (2.0%)

Bulk preparation of 2.0% agarose gel is outlined in Table D.

1. Measure 250 mL of 1X TBE Electrophoresis Buffer and pour into a 500 mL flask.
2. Pour 5.0 g of UltraSpec-Agarose™ into the prepared buffer. Swirl to disperse clumps.
3. With a marking pen, indicate the level of solution volume on the outside of the flask.
4. Heat the agarose solution as outlined previously for individual gel preparation. The heating time will require adjustment due to the larger total volume of gel buffer solution.
5. Cool the agarose solution to 60° C with swirling to promote even dissipation of heat. If evaporation has occurred, add distilled water to bring the solution up to the original volume as marked on the flask in step 3.
6. If staining with SYBR® Safe, add the entire volume of diluted SYBR® Safe from page 21 to the cooled agarose and mix well.
7. Dispense the required volume of cooled agarose solution for casting each gel. Measure 25 mL for each 7 x 7 cm gel, 50 mL for each 7 x 14 cm gel. **For this experiment, 7 x 7 cm gels are recommended.**
8. Allow the gel to completely solidify. It will become firm and cool to the touch after approximately 20 minutes. Then proceed with preparing the gel for electrophoresis. Alternatively, gels can be stored in water-tight plastic bags with 2 mL of 1X electrophoresis buffer for up to 1 week in the refrigerator.

Table  
D

Batch Prep of 2.0%  
UltraSpec-Agarose™

Amt of Agarose	+	1x TBE Electrophoresis Buffer
5.0 g		250 mL

#### Note:

The UltraSpec-Agarose™ kit component is usually labeled with the amount it contains. Please read the label carefully. If the amount of agarose is not specified or if the bottle's plastic seal has been broken, weigh the agarose to ensure you are using the correct amount.

#### NOTE:

QuickGuide instructions and guidelines for casting various agarose gels can be found on our website. [www.edvotek.com/quick-guides](http://www.edvotek.com/quick-guides)

